

ACMA SAR Test Report

APPLICANT : Quanta Computer Inc
EQUIPMENT : Laptop Computer
BRAND NAME : OLPC
MODEL NAME : XO-1.75; XO-1.75HS
STANDARD : ARPANSA Radiation Protection Standard
(Maximum Exposure Levels to Radiofrequency
Fields – 3 kHz to 300 GHz)
ACA Radiocommunications (Electromagnetic
Radiation - Human Exposure) Standard 2003
EN 62209-2:2010
TEST DATE(S) : Dec. 09, 2011

The product was integrated the WLAN Module (Brand Name: Lite-On / Model Name: WN6301MH) during the test.

The measurements shown in this test report were found to be in accordance with the requirements given in EUROPEAN COUNCIL DIRECTIVE 1999/519/EC, and in accordance with the procedure given in standard EN 62209-2:2010.

The test results in this report apply exclusively to the tested model / sample. Without written approval of SPORTON INTERNATIONAL (KUNSHAN) INC., the test report shall not be reproduced except in full.

Reviewed by:



Jones Tsai / Manager



SPORTON INTERNATIONAL (KUNSHAN) INC.
No. 3-2, PingXiang Road, Kunshan, Jiangsu Province, P.R.C.



Table of Contents

Revision History.....	3
1. Statement of Compliance	4
2. Administration Data.....	5
2.1 Testing Laboratory.....	5
2.2 Applicant.....	5
2.3 Manufacturer	5
2.4 Application Details.....	5
3. General Information	6
3.1 Description of Device Under Test (DUT).....	6
3.2 Product Photos.....	7
3.3 Applied Standards	8
3.4 Device Category and SAR Limits	8
3.5 Test Conditions	9
3.5.1 Ambient Condition	9
3.5.2 Test Configuration.....	9
4. Specific Absorption Rate (SAR).....	10
4.1 Introduction.....	10
4.2 SAR Definition	10
5. SAR Measurement System.....	11
3.6 E-Field Probe.....	12
5.1.1 E-Field Probe Specification	12
5.1.2 E-Field Probe Calibration.....	13
3.7 Data Acquisition Electronics (DAE).....	13
3.8 Robot.....	13
3.9 Measurement Server.....	14
3.10 Phantom.....	15
3.11 Device Holder.....	16
3.12 Data Storage and Evaluation.....	17
5.1.3 Data Storage	17
5.1.4 Data Evaluation	17
3.13 Test Equipment List.....	19
6. Tissue Simulating Liquids.....	19
7. Uncertainty Assessment	21
8. SAR Measurement Evaluation	23
8.1 Purpose of System Performance check	23
8.2 System Setup.....	23
8.3 Validation Results	24
9. DUT Testing Position.....	25
10. Measurement Procedures	28
10.1 Spatial Peak SAR Evaluation	28
10.2 Area & Zoom Scan Procedures.....	29
10.3 SAR Averaged Methods	29
10.4 Power Drift Monitoring.....	29
11. SAR Test Results	30
11.1 Conducted Power (Unit: dBm).....	30
11.2 Test Records for Body SAR Test	30
12. References.....	31
Appendix A. Plots of System Performance Check	
Appendix B. Plots of SAR Measurement	
Appendix C. DASYS Calibration Certificate	

1. Statement of Compliance

The maximum results of Specific Absorption Rate (SAR) found during testing for **Quanta Computer Inc;**
DUT: Laptop Computer; Brand Name: OLPC; Model Name: XO-1.75; XO-1.75HS are as follows.

Band	Position	SAR _{10g} (W/kg)
802.11 b/g	Body (0 cm)	0.582

This device is in compliance with Specific Absorption Rate (SAR) for general population/uncontrolled exposure limits (2.0 W/kg) specified in Council Recommendation 1999/519/EC, ICNIRP, and R&TTE Directive - 1999/5/EC and had been tested in accordance with the measurement methods and procedures specified in EN 62209-2:2010.

2. Administration Data

2.1 Testing Laboratory

Test Site	SPORTON INTERNATIONAL (KUNSHAN) INC.
Test Site Location	No. 3-2, PingXiang Road, Kunshan, Jiangsu Province, P.R.C. TEL: +86-0512-5790-0158 FAX: +86-0512-5790-0958

2.2 Applicant

Company Name	Quanta Computer Inc
Address	No.188, Wen Hwa 2nd Rd., Kuei Shan Hsiang, Tao Yuan Shien, TaiWan

2.3 Manufacturer

Company Name	Quanta Computer Inc
Address	No.188, Wen Hwa 2nd Rd., Kuei Shan Hsiang, Tao Yuan Shien, TaiWan

2.4 Application Details

Date of Receipt of Application	Nov. 16, 2011
Date of Start during the Test	Dec. 09, 2011
Date of End during the Test	Dec. 09, 2011

3. General Information

3.1 Description of Device Under Test (DUT)

Product Feature & Specification	
DUT Type	Laptop Computer
Brand Name	OLPC
Model Name	XO-1.75; XO-1.75HS
Tx Frequency	2412 MHz ~ 2472 MHz
Rx Frequency	2412 MHz ~ 2472 MHz
Maximum Output Power to Antenna	802.11b : 15.54 dBm 802.11g : 11.65 dBm
Antenna Type	PIFA Antenna
Type of Modulation	802.11b : DSSS (DBPSK / DQPSK / CCK) 802.11g : OFDM (BPSK / QPSK / 16QAM / 64QAM)
DUT Stage	Identical Prototype

Remark:

1. The above DUT's information was declared by manufacturer. Please refer to the specifications or user's manual for more detailed description.
2. The difference between sample 1(XO-1.75HS) and sample 2 (XO-1.75) is only for keyboard. The others are the same including circuit design, PCB board, structure and all components. It is special to declare. We choose sample 1 (XO-1.75HS) to perform all test, and sample 2 (XO-1.75) to test worse case base on sample 1 (XO-1.75HS).

3.2 Product Photos

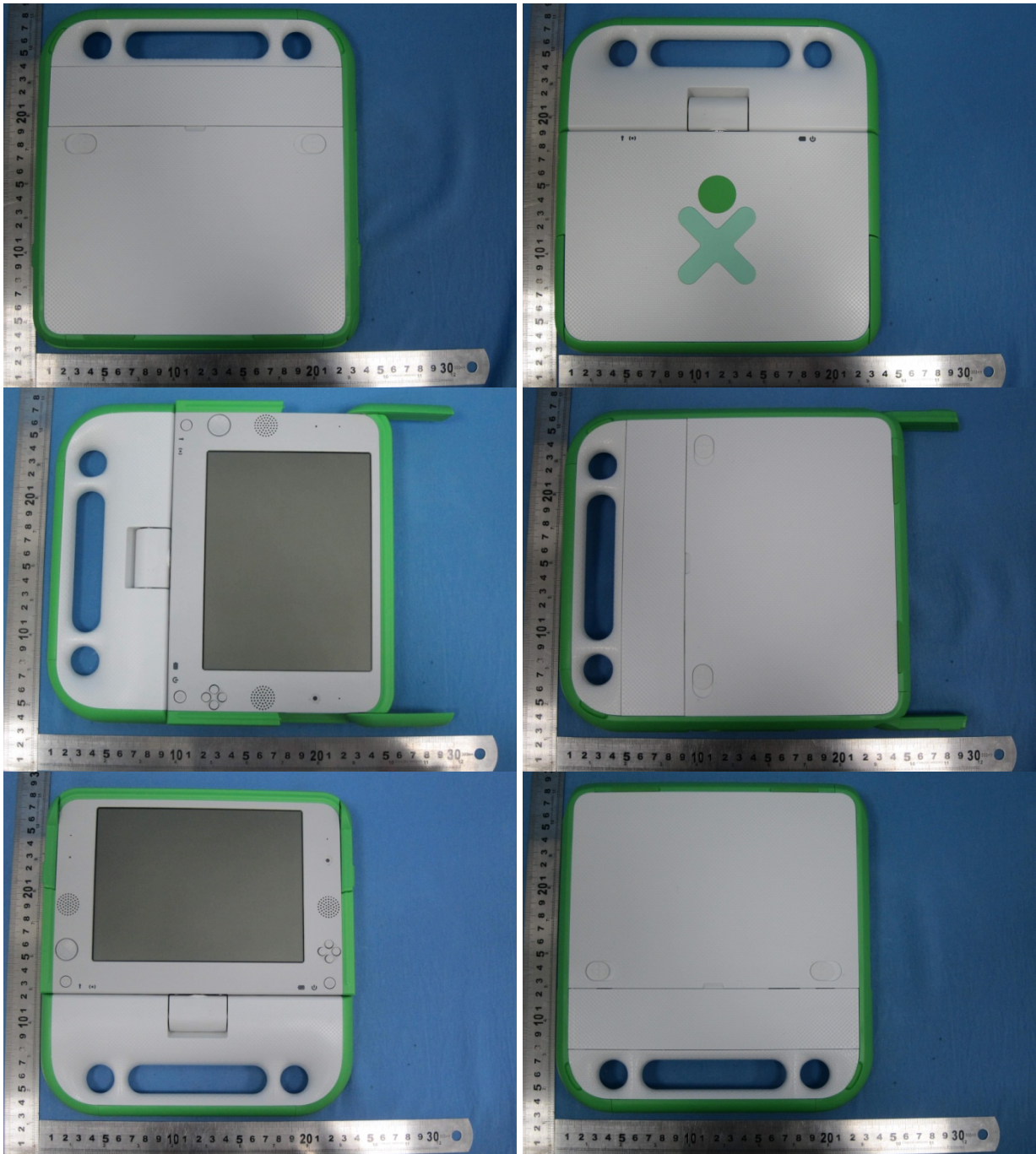



3.3 Applied Standards

The Specific Absorption Rate (SAR) testing specification, method and procedure for this device is in accordance with the following standards:

- Council Recommendation 1999/519/EC
- ARPANSA Radiation Protection Standard (Maximum Exposure Levels to Radiofrequency Fields – 3 kHz to 300 GHz)
- ACA Radio communications (Electromagnetic Radiation - Human Exposure) Standard 2003
- EN 62209-2:2010

3.4 Device Category and SAR Limits

This device belongs to portable device category because its radiating structure is allowed to be used within 20 centimeters of the body of the user. Limit for General Population/Uncontrolled exposure should be applied for this device, it is 2.0 W/kg as averaged over any 10 gram of tissue.

3.5 Test Conditions

3.5.1 Ambient Condition

Ambient Temperature	20 to 24 °C
Humidity	< 60 %

3.5.2 Test Configuration

The device was controlled by using a base station emulator. Communication between the device and the emulator was established by air link. The distance between the DUT and the antenna of the emulator is larger than 50 cm and the output power radiated from the emulator antenna is at least 30 dB smaller than the output power of DUT. The DUT was set from the emulator to radiate maximum output power during all tests.

For WLAN SAR testing, WLAN engineering testing software installed on the DUT can provide continuous transmitting RF signal. This RF signal utilized in SAR measurement has almost 100% duty cycle and its crest factor is 1.

4. Specific Absorption Rate (SAR)

4.1 Introduction

SAR is related to the rate at which energy is absorbed per unit mass in an object exposed to a radio field. The SAR distribution in a biological body is complicated and is usually carried out by experimental techniques or numerical modeling. The standard recommends limits for two tiers of groups, occupational/controlled and general population/uncontrolled, based on a person's awareness and ability to exercise control over his or her exposure. In general, occupational/controlled exposure limits are higher than the limits for general population/uncontrolled.

4.2 SAR Definition

The SAR definition is the time derivative (rate) of the incremental energy (dW) absorbed by (dissipated in) an incremental mass (dm) contained in a volume element (dv) of a given density (ρ). The equation description is as below:

$$\text{SAR} = \frac{d}{dt} \left(\frac{dW}{dm} \right) = \frac{d}{dt} \left(\frac{dW}{\rho dv} \right)$$

SAR is expressed in units of Watts per kilogram (W/kg)

SAR measurement can be either related to the temperature elevation in tissue by

$$\text{SAR} = C \left(\frac{\delta T}{\delta t} \right)$$

Where: C is the specific heat capacity, δT is the temperature rise and δt is the exposure duration, or related to the electrical field in the tissue by

$$\text{SAR} = \frac{\sigma |E|^2}{\rho}$$

Where: σ is the conductivity of the tissue, ρ is the mass density of the tissue and E is the RMS electrical field strength.

However for evaluating SAR of low power transmitter, electrical field measurement is typically applied.

5. SAR Measurement System

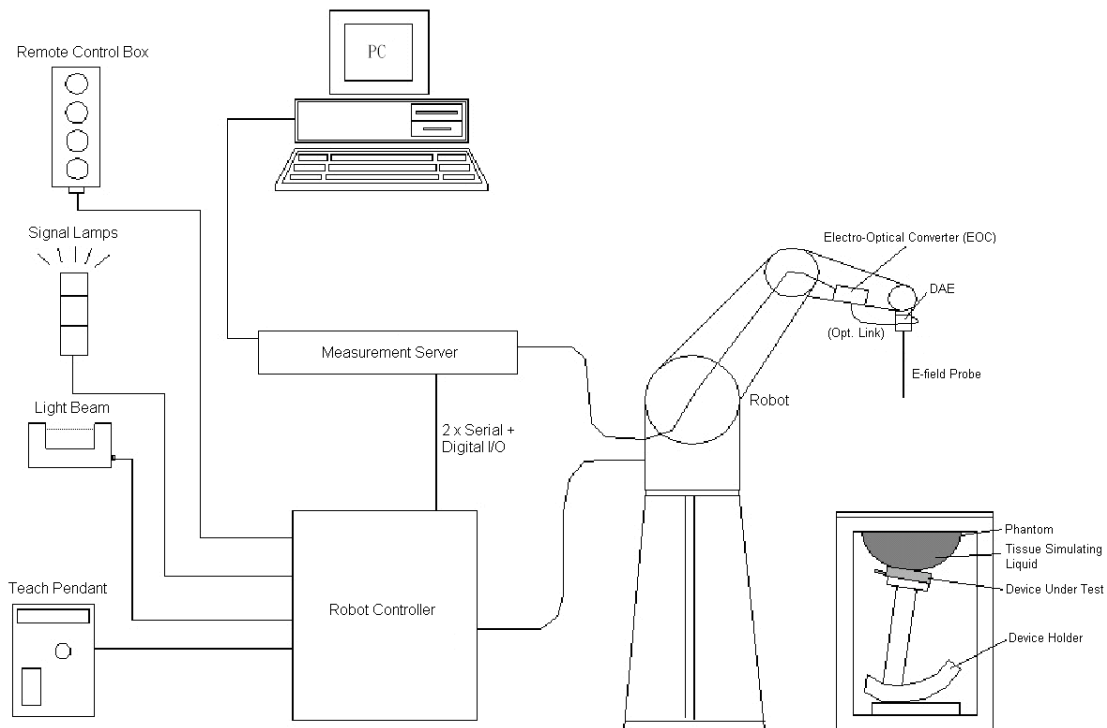

Fig 5.1 SPEAG DASY4 or DASY5 System Configurations

The DASY4 or DASY5 system for performance compliance tests is illustrated above graphically. This system consists of the following items:

- A standard high precision 6-axis robot with controller, a teach pendant and software
- A data acquisition electronic (DAE) attached to the robot arm extension
- A dosimetric probe equipped with an optical surface detector system
- The electro-optical converter (ECO) performs the conversion between optical and electrical signals
- A measurement server performs the time critical tasks such as signal filtering, control of the robot operation and fast movement interrupts.
- A probe alignment unit which improves the accuracy of the probe positioning
- A computer operating Windows XP
- DASY4 or DASY5 software
- Remote control with teach pendant and additional circuitry for robot safety such as warning lamps, etc.
- The SAM twin phantom
- A device holder
- Tissue simulating liquid
- Dipole for evaluating the proper functioning of the system

Some of the components are described in details in the following sub-sections.

3.6 E-Field Probe

The SAR measurement is conducted with the dosimetric probe (manufactured by SPEAG). The probe is specially designed and calibrated for use in liquid with high permittivity. The dosimetric probe has special calibration in liquid at different frequency. This probe has a built in optical surface detection system to prevent from collision with phantom.

5.1.1 E-Field Probe Specification

<EX3DV4 Probe>

Construction	Symmetrical design with triangular core Built-in shielding against static charges PEEK enclosure material (resistant to organic solvents, e.g., DGBE)	
Frequency	10 MHz to 6 GHz; Linearity: ± 0.2 dB	
Directivity	± 0.3 dB in HSL (rotation around probe axis) ± 0.5 dB in tissue material (rotation normal to probe axis)	
Dynamic Range	10 μ W/g to 100 mW/g; Linearity: ± 0.2 dB (noise: typically < 1 μ W/g)	
Dimensions	Overall length: 330 mm (Tip: 20 mm) Tip diameter: 2.5 mm (Body: 12 mm) Typical distance from probe tip to dipole centers: 1 mm	

Fig 5.2 Photo of EX3DV4

5.1.2 E-Field Probe Calibration

Each probe needs to be calibrated according to a dosimetric assessment procedure with accuracy better than $\pm 10\%$. The spherical isotropy shall be evaluated and within ± 0.25 dB. The sensitivity parameters (NormX, NormY, and NormZ), the diode compression parameter (DCP) and the conversion factor (ConvF) of the probe are tested. The calibration data can be referred to appendix C of this report.

3.7 Data Acquisition Electronics (DAE)

The data acquisition electronics (DAE) consists of a highly sensitive electrometer-grade preamplifier with auto-zeroing, a channel and gain-switching multiplexer, a fast 16 bit AD-converter and a command decoder and control logic unit. Transmission to the measurement server is accomplished through an optical downlink for data and status information as well as an optical uplink for commands and the clock.

The input impedance of the DAE is 200 MOhm; the inputs are symmetrical and floating. Common mode rejection is above 80 dB.



Fig 5.3 Photo of DAE

3.8 Robot

The SPEAG DASY system uses the high precision robots (DASY5: TX90XL) type from Stäubli SA (France). For the 6-axis controller system, the robot controller version (DASY5: CS8c) from Stäubli is used. The Stäubli robot series have many features that are important for our application:

- High precision (repeatability ± 0.035 mm)
- High reliability (industrial design)
- Jerk-free straight movements
- Low ELF interference (the closed metallic construction shields against motor control fields)



Fig 5.4 Photo of DASY5

3.9 Measurement Server

The measurement server is based on a PC/104 CPU board with CPU (DASY5: 400 MHz, Intel Celeron), chipdisk (DASY5: 128 MB), RAM (DASY5: 128 MB). The necessary circuits for communication with the DAE electronic box, as well as the 16 bit AD converter system for optical detection and digital I/O interface are contained on the DASY I/O board, which is directly connected to the PC/104 bus of the CPU board.

The measurement server performs all the real-time data evaluation for field measurements and surface detection, controls robot movements and handles safety operations.



Fig 5.5 Photo of Server for DASY5

3.10 Phantom

<SAM Twin Phantom>

Shell Thickness	2 ± 0.2 mm; Center ear point: 6 ± 0.2 mm
Filling Volume	Approx. 25 liters
Dimensions	Length: 1000 mm; Width: 500 mm; Height: adjustable feet
Measurement Areas	Left Hand, Right Hand, Flat Phantom



Fig 5.1 Photo of SAM Phantom

The bottom plate contains three pair of bolts for locking the device holder. The device holder positions are adjusted to the standard measurement positions in the three sections. A white cover is provided to tap the phantom during off-periods to prevent water evaporation and changes in the liquid parameters. On the phantom top, three reference markers are provided to identify the phantom position with respect to the robot.

<ELI4 Phantom>

Shell Thickness	2 ± 0.2 mm (sagging: <1%)
Filling Volume	Approx. 30 liters
Dimensions	Major ellipse axis: 600 mm Minor axis: 400 mm



Fig 5.2 Photo of ELI4 Phantom

The ELI4 phantom is intended for compliance testing of handheld and body-mounted wireless devices in the frequency range of 30 MHz to 6 GHz. ELI4 is fully compatible with standard and all known tissue simulating liquids.

3.11 Device Holder

<Laptop Extension Kit>

The extension is lightweight and made of POM, acrylic glass and foam. It fits easily on the upper part of the mounting device in place of the phone positioned. The extension is fully compatible with the SAM Twin and ELI phantoms.

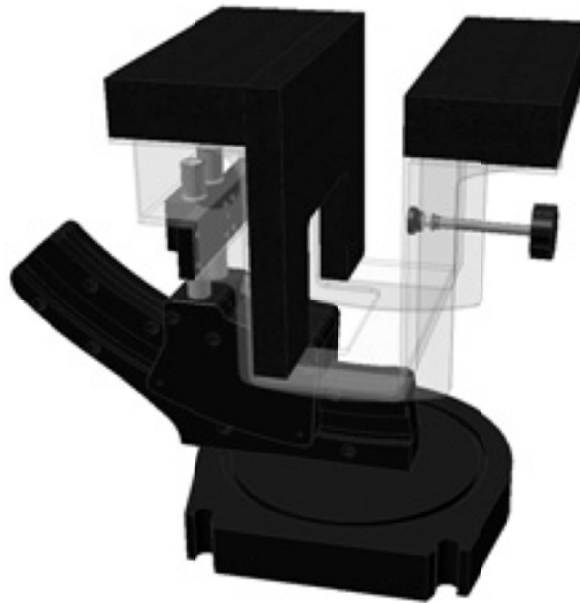

Fig 5.3 Laptop Extension Kit

3.12 Data Storage and Evaluation

5.1.3 Data Storage

The DASY software stores the assessed data from the data acquisition electronics as raw data (in microvolt readings from the probe sensors), together with all the necessary software parameters for the data evaluation (probe calibration data, liquid parameters and device frequency and modulation data) in measurement files. The post-processing software evaluates the desired unit and format for output each time the data is visualized or exported. This allows verification of the complete software setup even after the measurement and allows correction of erroneous parameter settings. For example, if a measurement has been performed with an incorrect crest factor parameter in the device setup, the parameter can be corrected afterwards and the data can be reevaluated.

The measured data can be visualized or exported in different units or formats, depending on the selected probe type (e.g., [V/m], [A/m], [mW/g]). Some of these units are not available in certain situations or give meaningless results, e.g., a SAR-output in a non-lose media, will always be zero. Raw data can also be exported to perform the evaluation with other software packages.

5.1.4 Data Evaluation

The DASY post-processing software (SEMCAD) automatically executes the following procedures to calculate the field units from the microvolt readings at the probe connector. The parameters used in the evaluation are stored in the configuration modules of the software :

Probe parameters :	- Sensitivity	Norm _i , a _{i0} , a _{i1} , a _{i2}
	- Conversion factor	ConvF _i
	- Diode compression point	dcp _i
Device parameters :	- Frequency	f
	- Crest factor	cf
Media parameters :	- Conductivity	σ
	- Density	ρ

These parameters must be set correctly in the software. They can be found in the component documents or they can be imported into the software from the configuration files issued for the DASY components. In the direct measuring mode of the multi-meter option, the parameters of the actual system setup are used. In the scan visualization and export modes, the parameters stored in the corresponding document files are used.

The first step of the evaluation is a linearization of the filtered input signal to account for the compression characteristics of the detector diode. The compensation depends on the input signal, the diode type and the DC-transmission factor from the diode to the evaluation electronics. If the exciting field is pulsed, the crest factor of the signal must be known to correctly compensate for peak power.

The formula for each channel can be given as :

$$V_i = U_i + U_i^2 \cdot \frac{cf}{dcp_i}$$

with V_i = compensated signal of channel i, (i = x, y, z)
 U_i = input signal of channel i, (i = x, y, z)
 cf = crest factor of exciting field (DASY parameter)
 dcp_i = diode compression point (DASY parameter)

From the compensated input signals, the primary field data for each channel can be evaluated :

$$\text{E-field Probes : } E_i = \sqrt{\frac{V_i}{\text{Norm}_i \cdot \text{ConvF}}}$$

$$\text{H-field Probes : } H_i = \sqrt{V_i} \cdot \frac{a_{i0} + a_{i1}f + a_{i2}f^2}{f}$$

with V_i = compensated signal of channel i, (i = x, y, z)
 Norm_i = sensor sensitivity of channel i, (i = x, y, z), $\mu\text{V}/(\text{V/m})^2$ for E-field Probes
 ConvF = sensitivity enhancement in solution
 a_{ij} = sensor sensitivity factors for H-field probes
 f = carrier frequency [GHz]
 E_i = electric field strength of channel i in V/m
 H_i = magnetic field strength of channel i in A/m

The RSS value of the field components gives the total field strength (Hermitian magnitude) :

$$E_{\text{tot}} = \sqrt{E_x^2 + E_y^2 + E_z^2}$$

The primary field data are used to calculate the derived field units.

$$\text{SAR} = E_{\text{tot}}^2 \cdot \frac{\sigma}{\rho \cdot 1000}$$

with SAR = local specific absorption rate in mW/g
 E_{tot} = total field strength in V/m
 σ = conductivity in [mho/m] or [Siemens/m]
 ρ = equivalent tissue density in g/cm^3

Note that the density is set to 1, to account for actual head tissue density rather than the density of the tissue simulating liquid.

3.13 Test Equipment List

Manufacturer	Name of Equipment	Type/Model	Serial Number	Calibration	
				Last Cal.	Due Date
SPEAG	Dosimetric E-Field Probe	EX3DV4	3697	Sep. 02, 2011	Sep. 01, 2012
SPEAG	Data Acquisition Electronics	DAE4	1210	Nov. 18, 2011	Nov. 17, 2012
SPEAG	2450MHz System Validation Kit	D2450V2	840	Mar. 18, 2010	Mar. 17, 2012
SPEAG	ELI4 Phantom	QD OVA 001 BB	1079	NCR	NCR
Agilent	ENA Series Network Analyzer	E5071C	MY46111157	Apr. 07, 2011	Apr. 06, 2012
Agilent	Wireless Communication Test Set	E5515C	MY50264165	Mar. 30, 2011	Mar. 29, 2012
Agilent	Dielectric Probe Kit	85070E	MY44300475	NCR	NCR
Agilent	Base Station	E5515C	GB47050646	Aug. 18, 2011	Aug. 17, 2012
AR	Amplifier	551G4	333096	NCR	NCR
R&S	Spectrum Analyzer	FSP30	101400	Jun. 2, 2011	Jun. 1, 2012
R&S	Signal Generator	SMR40	100455	Jan. 06, 2011	Jan. 05, 2012

Remark: Calibration Interval of instruments listed above is two year.

Table 5.1 Test Equipment List

Note: The calibration certificate of DASY can be referred to appendix C of this report.

6. Tissue Simulating Liquids

For the measurement of the field distribution inside the SAM phantom with DASY, the phantom must be filled with around 25 liters of homogeneous body tissue simulating liquid. For head SAR testing, the liquid height from the ear reference point (ERP) of the phantom to the liquid top surface is larger than 15 cm, which is shown in Fig. 6.1. For body SAR testing, the liquid height from the center of the flat phantom to the liquid top surface is larger than 15 cm, which is shown in Fig. 6.2.



Fig 6.1 Photo of Liquid Height for Head SAR



Fig 6.2 Photo of Liquid Height for Body SAR

The following table gives the recipes for tissue simulating liquid.

Frequency (MHz)	Water (%)	Sugar (%)	Cellulose (%)	Salt (%)	Preventol (%)	DGBE (%)	Conductivity (σ)	Permittivity (ϵ_r)
2450	55.0	0	0	0	0	45.0	1.80	39.2

Table 6.1 Recipes of Tissue Simulating Liquid

The following table gives the targets for tissue simulating liquid.

Frequency (MHz)	Conductivity (σ)	$\pm 5\%$ Range	Permittivity (ϵ_r)	$\pm 5\%$ Range
2450	1.80	1.71 ~ 1.89	39.2	37.2 ~ 41.2

Table 6.2 Targets of Tissue Simulating Liquid

The dielectric parameters of the liquids were verified prior to the SAR evaluation using an Agilent 85070D Dielectric Probe Kit and an Agilent Network Analyzer.

The following table shows the measuring results for simulating liquid.

Freq.	Liquid Type	Temp. (°C)	Conductivity (σ)	Permittivity (ϵ_r)	Conductivity Target (σ)	Permittivity Target (ϵ_r)	Delta (σ) (%)	Delta (ϵ_r) (%)	Limit (%)	Date
2450	Head	21.5	1.83	39.7	1.8	39.2	1.67	1.28	± 5	Dec. 09, 2011

Table 6.3 Measuring Results for Simulating Liquid

7. Uncertainty Assessment

The component of uncertainty may generally be categorized according to the methods used to evaluate them. The evaluation of uncertainty by the statistical analysis of a series of observations is termed a Type A evaluation of uncertainty. The evaluation of uncertainty by means other than the statistical analysis of a series of observation is termed a Type B evaluation of uncertainty. Each component of uncertainty, however evaluated, is represented by an estimated standard deviation, termed standard uncertainty, which is determined by the positive square root of the estimated variance.

A Type A evaluation of standard uncertainty may be based on any valid statistical method for treating data. This includes calculating the standard deviation of the mean of a series of independent observations; using the method of least squares to fit a curve to the data in order to estimate the parameter of the curve and their standard deviations; or carrying out an analysis of variance in order to identify and quantify random effects in certain kinds of measurement.

A type B evaluation of standard uncertainty is typically based on scientific judgment using all of the relevant information available. These may include previous measurement data, experience and knowledge of the behavior and properties of relevant materials and instruments, manufacture’s specification, data provided in calibration reports and uncertainties assigned to reference data taken from handbooks. Broadly speaking, the uncertainty is either obtained from an outdoor source or obtained from an assumed distribution, such as the normal distribution, rectangular or triangular distributions indicated in Table 7.1

Uncertainty Distributions	Normal	Rectangular	Triangular	U-Shape
Multi-plying Factor ^(a)	1/k ^(b)	1/√3	1/√6	1/√2

(a) standard uncertainty is determined as the product of the multiplying factor and the estimated range of variations in the measured quantity

(b) κ is the coverage factor

Table 7.1 Standard Uncertainty for Assumed Distribution

The combined standard uncertainty of the measurement result represents the estimated standard deviation of the result. It is obtained by combining the individual standard uncertainties of both Type A and Type B evaluation using the usual “root-sum-squares” (RSS) methods of combining standard deviations by taking the positive square root of the estimated variances.

Expanded uncertainty is a measure of uncertainty that defines an interval about the measurement result within which the measured value is confidently believed to lie. It is obtained by multiplying the combined standard uncertainty by a coverage factor. Typically, the coverage factor ranges from 2 to 3. Using a coverage factor allows the true value of a measured quantity to be specified with a defined probability within the specified uncertainty range. For purpose of this document, a coverage factor two is used, which corresponds to confidence interval of about 95 %. The DASY uncertainty Budget is showed in Table 7.2 and Table 7.3.

Error Description	Uncertainty Value (±%)	Probability Distribution	Divisor	Ci (10g)	Standard Uncertainty (10g)
Measurement System					
Probe Calibration	6.0	Normal	1	1	± 6.0 %
Axial Isotropy	4.7	Rectangular	√3	0.7	± 1.9 %
Hemispherical Isotropy	9.6	Rectangular	√3	0.7	± 3.9 %
Boundary Effects	1.0	Rectangular	√3	1	± 0.6 %
Linearity	4.7	Rectangular	√3	1	± 2.7 %
System Detection Limits	1.0	Rectangular	√3	1	± 0.6 %
Readout Electronics	0.3	Normal	1	1	± 0.3 %
Response Time	0.8	Rectangular	√3	1	± 0.5 %
Integration Time	2.6	Rectangular	√3	1	± 1.5 %
RF Ambient Noise	3.0	Rectangular	√3	1	± 1.7 %
RF Ambient Reflections	3.0	Rectangular	√3	1	± 1.7 %
Probe Positioner	0.4	Rectangular	√3	1	± 0.2 %
Probe Positioning	2.9	Rectangular	√3	1	± 1.7 %
Max. SAR Eval.	1.0	Rectangular	√3	1	± 0.6 %
Test Sample Related					
Device Positioning	2.9	Normal	1	1	± 2.9 %
Device Holder	3.6	Normal	1	1	± 3.6 %
Power Drift	5.0	Rectangular	√3	1	± 2.9 %
Phantom and Setup					
Phantom Uncertainty	4.0	Rectangular	√3	1	± 2.3 %
Liquid Conductivity (Target)	5.0	Rectangular	√3	0.43	± 1.2 %
Liquid Conductivity (Meas.)	2.5	Normal	1	0.43	± 1.1 %
Liquid Permittivity (Target)	5.0	Rectangular	√3	0.49	± 1.4 %
Liquid Permittivity (Meas.)	2.5	Normal	1	0.49	± 1.2 %
Combined Standard Uncertainty					± 10.76 %
Coverage Factor for 95 %					K = 2
Expanded Uncertainty					± 21.51 %

Table 7.2 Uncertainty Budget of DASY for frequency range 300 MHz to 3 GHz

8. SAR Measurement Evaluation

Each DASY system is equipped with one or more system validation kits. These units, together with the predefined measurement procedures within the DASY software, enable the user to conduct the system performance check and system validation. System validation kit includes a dipole, tripod holder to fix it underneath the flat phantom and a corresponding distance holder.

8.1 Purpose of System Performance check

The system performance check verifies that the system operates within its specifications. System and operator errors can be detected and corrected. It is recommended that the system performance check be performed prior to any usage of the system in order to guarantee reproducible results. The system performance check uses normal SAR measurements in a simplified setup with a well characterized source. This setup was selected to give a high sensitivity to all parameters that might fail or vary over time. The system check does not intend to replace the calibration of the components, but indicates situations where the system uncertainty is exceeded due to drift or failure.

8.2 System Setup

In the simplified setup for system evaluation, the DUT is replaced by a calibrated dipole and the power source is replaced by a continuous wave that comes from a signal generator. The calibrated dipole must be placed beneath the flat phantom section of the SAM twin phantom with the correct distance holder. The distance holder should touch the phantom surface with a light pressure at the reference marking and be oriented parallel to the long side of the phantom. The equipment setup is shown below:

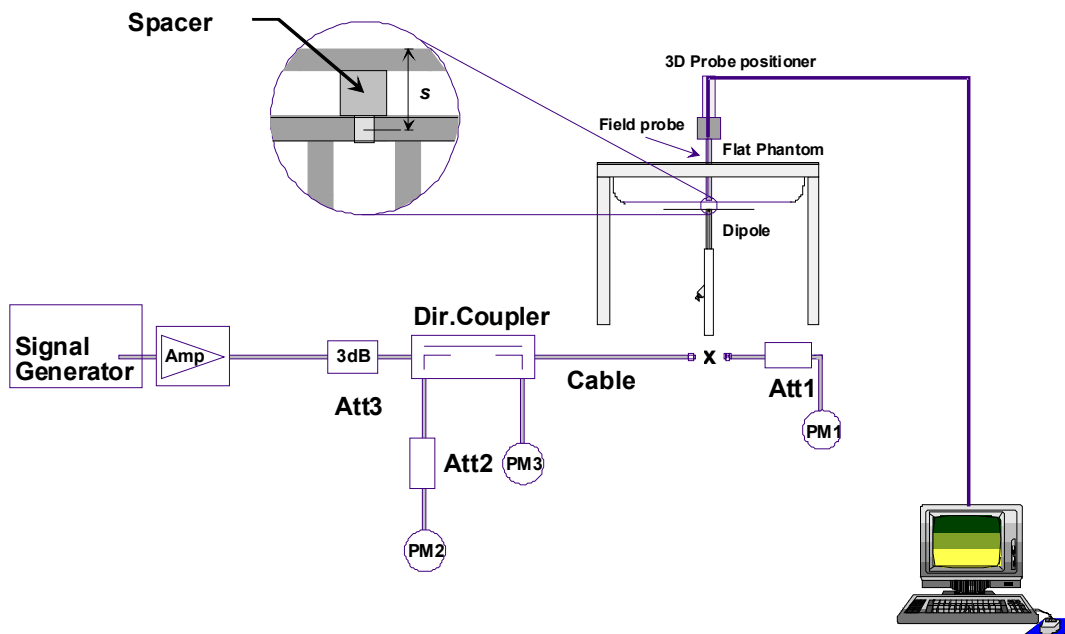

Fig 8.1 System Setup for System Evaluation

1. Signal Generator
2. Amplifier
3. Directional Coupler
4. Power Meter
5. Calibrated Dipole

The output power on dipole port must be calibrated to 24 dBm (250 mW) before dipole is connected.



Fig 8.2 Photo of Dipole Setup

8.3 Validation Results

Comparing to the original SAR value provided by SPEAG, the validation data should be within its specification of 10 %. Table 8.1 shows the target SAR and measured SAR after normalized to 1W input power. The table below indicates the system performance check can meet the variation criterion and the plots can be referred to Appendix A of this report.

Measurement Date	Frequency (MHz)	Liquid Type	Targeted SAR _{10g} (W/kg)	Measured SAR _{10g} (W/kg)	Normalized SAR (W/kg)	Deviation (%)
Dec. 09, 2011	2450	Head	24.8	6.22	24.88	0.32

Table 8.1 Target and Measurement SAR after Normalized

9. DUT Testing Position

This DUT was tested in six different positions. They are bottom of the DUT in laptop PC mode, bottom of the DUT in tablet PC mode, primary landscape, secondary landscape, primary portrait, and secondary portrait. In these positions, the surface of the DUT is touching with phantom 0 cm gap, and the antenna of the DUT can be rotated through 0 degree or 180 degrees during the test. The illustrations for lap-touching position are as below.

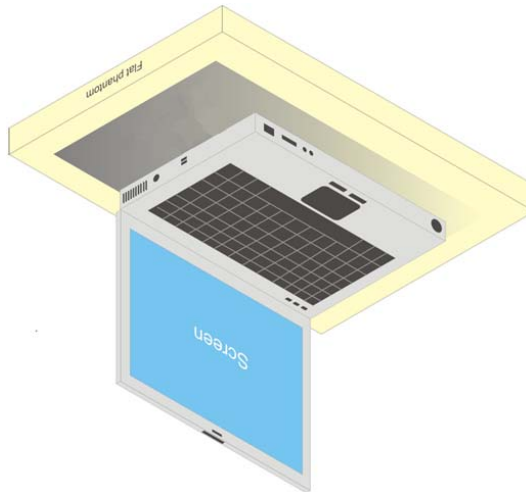

Fig 9.1 Illustration for Lap-touching Position

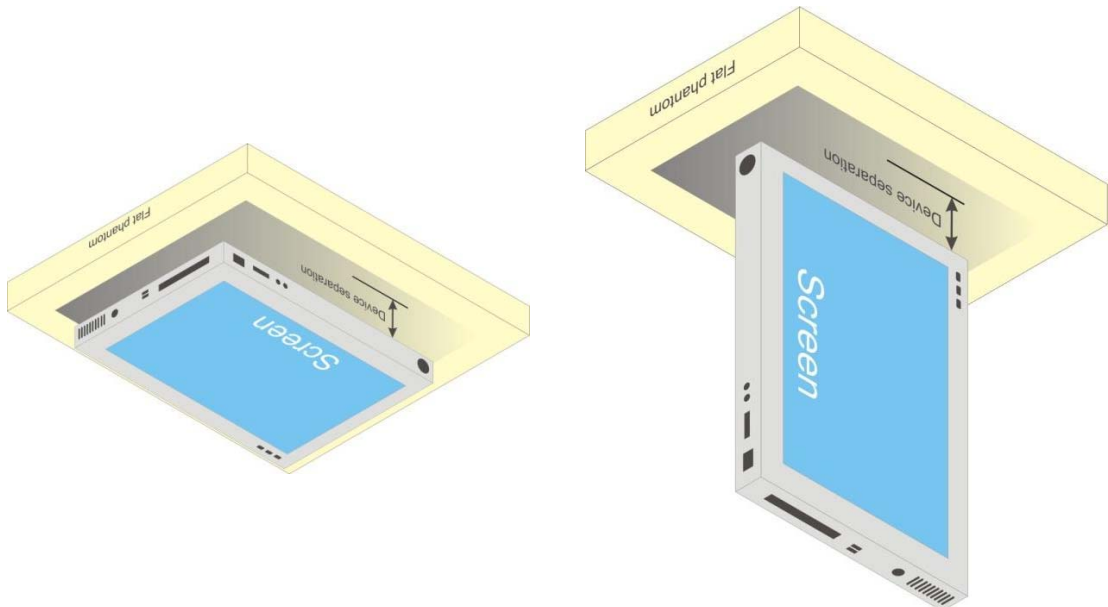

Fig 9.2 Illustration for Tablet PC on Lap-touching Position

<DUT Setup Photos>



Bottom of Laptop – Antenna Position 0°



Bottom of Laptop – Antenna Position 180°



Bottom of Tablet – Antenna Position 0°

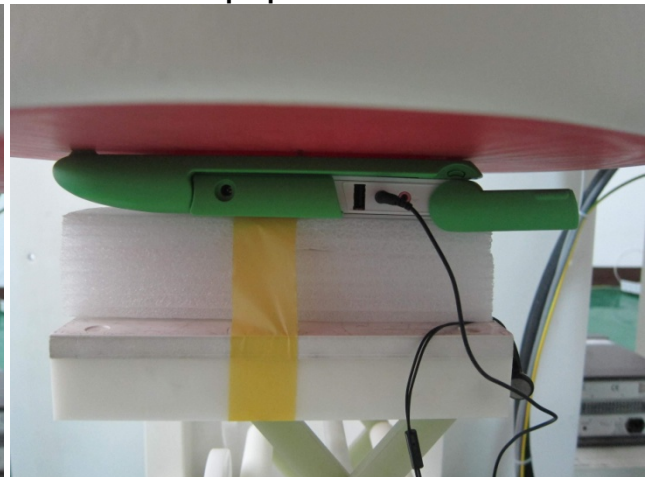

Bottom of Tablet – Antenna Position 180°



Primary Landscape – Antenna Position 180°



Primary Portrait – Antenna Position 0°



Primary Portrait – Antenna Position 180°



Secondary Landscape – Antenna Position 0°



Secondary Portrait – Antenna Position 0°



Secondary Portrait – Antenna Position 180°

10. Measurement Procedures

The measurement procedures are as follows:

- (a) For WWAN function, link DUT with base station emulator in middle channel
- (b) Set base station emulator to allow DUT to radiate maximum output power
- (c) For WLAN function, using engineering software to transmit RF power continuously (continuous Tx) in the middle channel
- (d) Measure output power through RF cable and power meter
- (e) Place the DUT in the positions described in the last section
- (f) Set scan area, grid size and other setting on the DASY software
- (g) Taking data for the middle channel on each testing position
- (h) Find out the largest SAR result on these testing positions of each band
- (i) Measure SAR results for the lowest and highest channels in worst SAR testing position

According to the test standard, the recommended procedure for assessing the peak spatial-average SAR value consists of the following steps:

- (a) Power reference measurement
- (b) Area scan
- (c) Zoom scan
- (d) Power drift measurement

10.1 Spatial Peak SAR Evaluation

The procedure for spatial peak SAR evaluation has been implemented according to the test standard. It can be conducted for 1g and 10g, as well as for user-specific masses. The DASY software includes all numerical procedures necessary to evaluate the spatial peak SAR value.

The base for the evaluation is a "cube" measurement. The measured volume must include the 1g and 10g cubes with the highest averaged SAR values. For that purpose, the center of the measured volume is aligned to the interpolated peak SAR value of a previously performed area scan.

The entire evaluation of the spatial peak values is performed within the post-processing engine (SEMCAD). The system always gives the maximum values for the 1g and 10g cubes. The algorithm to find the cube with highest averaged SAR is divided into the following stages:

- (a) Extraction of the measured data (grid and values) from the Zoom Scan
- (b) Calculation of the SAR value at every measurement point based on all stored data (A/D values and measurement parameters)
- (c) Generation of a high-resolution mesh within the measured volume
- (d) Interpolation of all measured values from the measurement grid to the high-resolution grid
- (e) Extrapolation of the entire 3-D field distribution to the phantom surface over the distance from sensor to surface
- (f) Calculation of the averaged SAR within masses of 1g and 10g

10.2 Area & Zoom Scan Procedures

First Area Scan is used to locate the approximate location(s) of the local peak SAR value(s). The measurement grid within an Area Scan is defined by the grid extent, grid step size and grid offset. Next, in order to determine the EM field distribution in a three-dimensional spatial extension, Zoom Scan is required. The Zoom Scan measures 5x5x7 points with step size 8, 8 and 5 mm for 300 MHz to 3 GHz, and 8x8x8 points with step size 4, 4 and 2.5 mm for 3 GHz to 6 GHz. The Zoom Scan is performed around the highest E-field value to determine the averaged SAR-distribution over 10 g.

10.3 SAR Averaged Methods

In DASy, the interpolation and extrapolation are both based on the modified Quadratic Shepard's method. The interpolation scheme combines a least-square fitted function method and a weighted average method which are the two basic types of computational interpolation and approximation.

Extrapolation routines are used to obtain SAR values between the lowest measurement points and the inner phantom surface. The extrapolation distance is determined by the surface detection distance and the probe sensor offset. The uncertainty increases with the extrapolation distance. To keep the uncertainty within 1% for the 1 g and 10 g cubes, the extrapolation distance should not be larger than 5 mm.

10.4 Power Drift Monitoring

All SAR testing is under the DUT install full charged battery and transmit maximum output power. In DASy measurement software, the power reference measurement and power drift measurement procedures are used for monitoring the power drift of DUT during SAR test. Both these procedures measure the field at a specified reference position before and after the SAR testing. The software will calculate the field difference in dB. If the power drift more than 5%, the SAR will be retested.

11. SAR Test Results Conducted Power (Unit: dBm)

<WLAN>

Band	802.11b			802.11g		
Data Rate	1M			6M		
Channel	1	7	13	1	7	13
Frequency (MHz)	2412	2442	2472	2412	2442	2472
Power	15.15	15.54	15.48	11.65	10.96	11.08

Note: The data rates for WLAN SAR testing were set in 1Mbps for 802.11b and 6Mbps for 802.11g due to the highest RF output power.

11.2 Test Records for Body SAR Test

<WLAN>

Plot No.	Band	Mode	Test Position	Gap (cm)	Ch.	Sample	DUT Mode	Antenna Position	SAR _{10g} (W/kg)
1	WLAN2.4G	802.11b	Bottom of Laptop	0	7	#1	Laptop PC	0°	0.048
2	WLAN2.4G	802.11b	Bottom of Laptop	0	7	#1	Laptop PC	180°	0.051
3	WLAN2.4G	802.11b	Bottom of Tablet	0	7	#1	Tablet PC	0°	0.105
4	WLAN2.4G	802.11b	Bottom of Tablet	0	7	#1	Tablet PC	180°	0.128
5	WLAN2.4G	802.11b	Primary Landscape	0	7	#1	Tablet PC	180°	0.00919
6	WLAN2.4G	802.11b	Primary Portrait	0	7	#1	Tablet PC	0°	0.369
7	WLAN2.4G	802.11b	Primary Portrait	0	7	#1	Tablet PC	180°	0.557
8	WLAN2.4G	802.11b	Secondary Landscape	0	7	#1	Tablet PC	0°	0.024
9	WLAN2.4G	802.11b	Secondary Portrait	0	7	#1	Tablet PC	0°	0.00377
10	WLAN2.4G	802.11b	Secondary Portrait	0	7	#1	Tablet PC	180°	0.00707
11	WLAN2.4G	802.11g	Primary Portrait	0	7	#1	Tablet PC	180°	0.221
12	WLAN2.4G	802.11b	Primary Portrait	0	1	#1	Tablet PC	180°	0.516
13	WLAN2.4G	802.11b	Primary Portrait	0	13	#1	Tablet PC	180°	0.568
14	WLAN2.4G	802.11b	Primary Portrait	0	13	#2	Tablet PC	180°	0.582

Test Engineer : Suhe Yin

12. References

- [1] Council Recommendation 1999/519/EC of July 1999 on the limitation of exposure of the general public to electromagnetic fields (0Hz to 300 GHz)
- [2] EN 62209-2, "Human exposure to radio frequency fields from hand-held and body-mounted wireless communication devices. Human models, instrumentation, and procedures. Procedure to determine the specific absorption rate (SAR) for wireless communication devices used in close proximity to the human body (frequency range of 30 MHz to 6 GHz)", August 2010
- [3] SPEAG DASY System Handbook



Appendix A. Plots of System Performance Check

The plots are shown as follows.

System Check_Head_2450MHz_111209

DUT: D2450V2 - SN: 840

Communication System: CW; Frequency: 2450 MHz; Duty Cycle: 1:1

Medium: HSL_2450_111209 Medium parameters used: $f = 2450$ MHz; $\sigma = 1.825$ mho/m; $\epsilon_r =$

39.664 ; $\rho = 1000$ kg/m³

Ambient Temperature : 23.5 °C ; Liquid Temperature : 21.5 °C

DASY5 Configuration:

- Probe: EX3DV4 - SN3697; ConvF(6.67, 6.67, 6.67); Calibrated: 2011-9-2
- Sensor-Surface: 4mm (Mechanical Surface Detection)
- Electronics: DAE4 Sn1210; Calibrated: 2011-11-18
- Phantom: SAM3; Type: SAM; Serial: TP-1079
- Measurement SW: DASY52, Version 52.6 (2); SEMCAD X Version 14.4.5 (3634)

Pin=250mW/Area Scan (91x91x1): Measurement grid: dx=10mm, dy=10mm

Maximum value of SAR (interpolated) = 16.149 mW/g

Pin=250mW/Zoom Scan (7x7x7)/Cube 0: Measurement grid: dx=5mm, dy=5mm, dz=5mm

Reference Value = 92.105 V/m; Power Drift = 0.02 dB

Peak SAR (extrapolated) = 30.898 W/kg

SAR(1 g) = 13.9 mW/g; SAR(10 g) = 6.22 mW/g

Maximum value of SAR (measured) = 15.804 mW/g

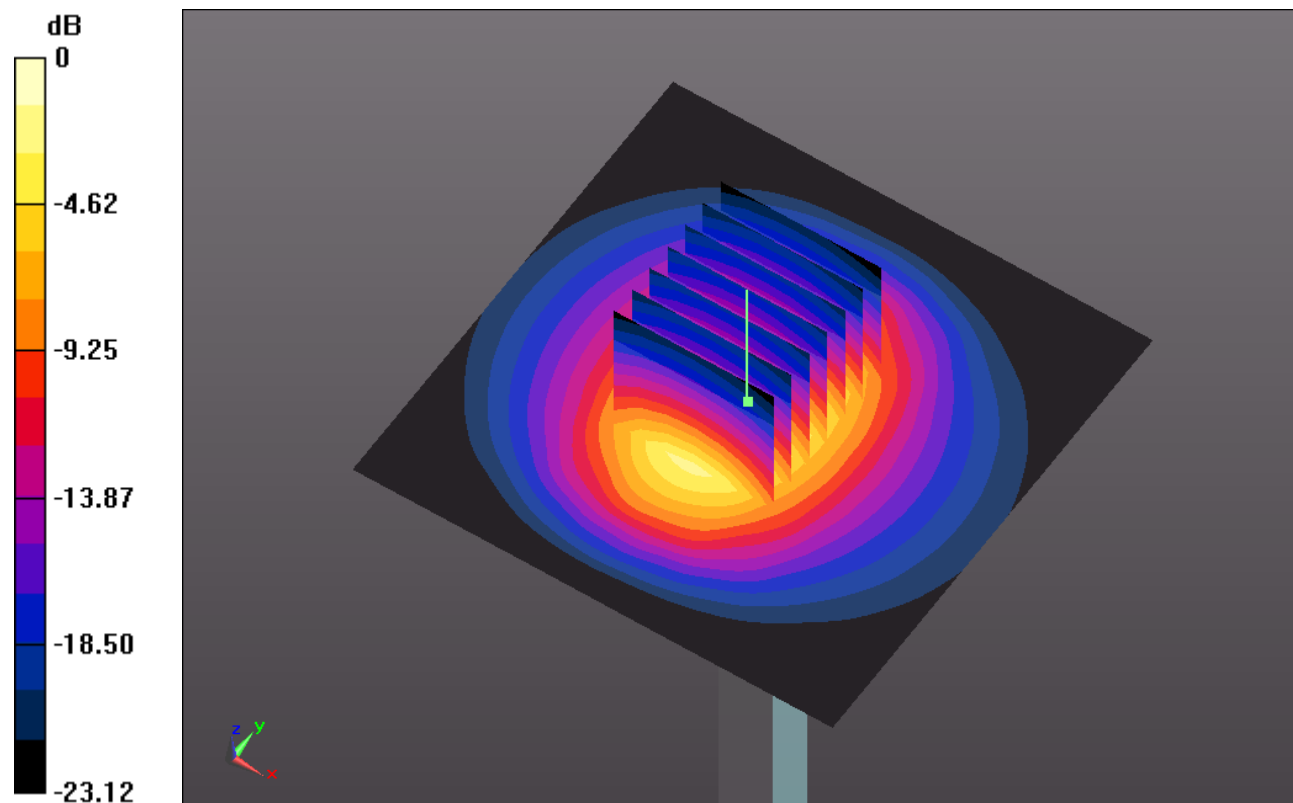

0 dB = 15.800mW/g



Appendix B. Plots of SAR Measurement

The plots are shown as follows.

#01 802.11b_Bottom of Laptop_0cm_Ch7_Laptop PC_Ant Degree 0_Sample #1

DUT: 310902B

Communication System: WIFI; Frequency: 2442 MHz; Duty Cycle: 1:1

Medium: HSL_2450_111209 Medium parameters used: $f = 2442$ MHz; $\sigma = 1.817$ mho/m; $\epsilon_r =$

39.689 ; $\rho = 1000$ kg/m³

Ambient Temperature : 23.5 °C ; Liquid Temperature : 21.5 °C

DASY5 Configuration:

- Probe: EX3DV4 - SN3697; ConvF(6.67, 6.67, 6.67); Calibrated: 2011-9-2
- Sensor-Surface: 4mm (Mechanical Surface Detection)
- Electronics: DAE4 Sn1210; Calibrated: 2011-11-18
- Phantom: SAM3; Type: SAM; Serial: TP-1079
- Measurement SW: DASY52, Version 52.6 (2); SEMCAD X Version 14.4.5 (3634)

Ch7/Area Scan (202x235x1): Measurement grid: dx=15mm, dy=15mm

Maximum value of SAR (interpolated) = 0.063 mW/g

Ch7/Zoom Scan (5x5x7)/Cube 0: Measurement grid: dx=8mm, dy=8mm, dz=5mm

Reference Value = 4.548 V/m; Power Drift = 0.09 dB

Peak SAR (extrapolated) = 0.091 W/kg

SAR(1 g) = 0.059 mW/g; SAR(10 g) = 0.048 mW/g

Maximum value of SAR (measured) = 0.091 mW/g

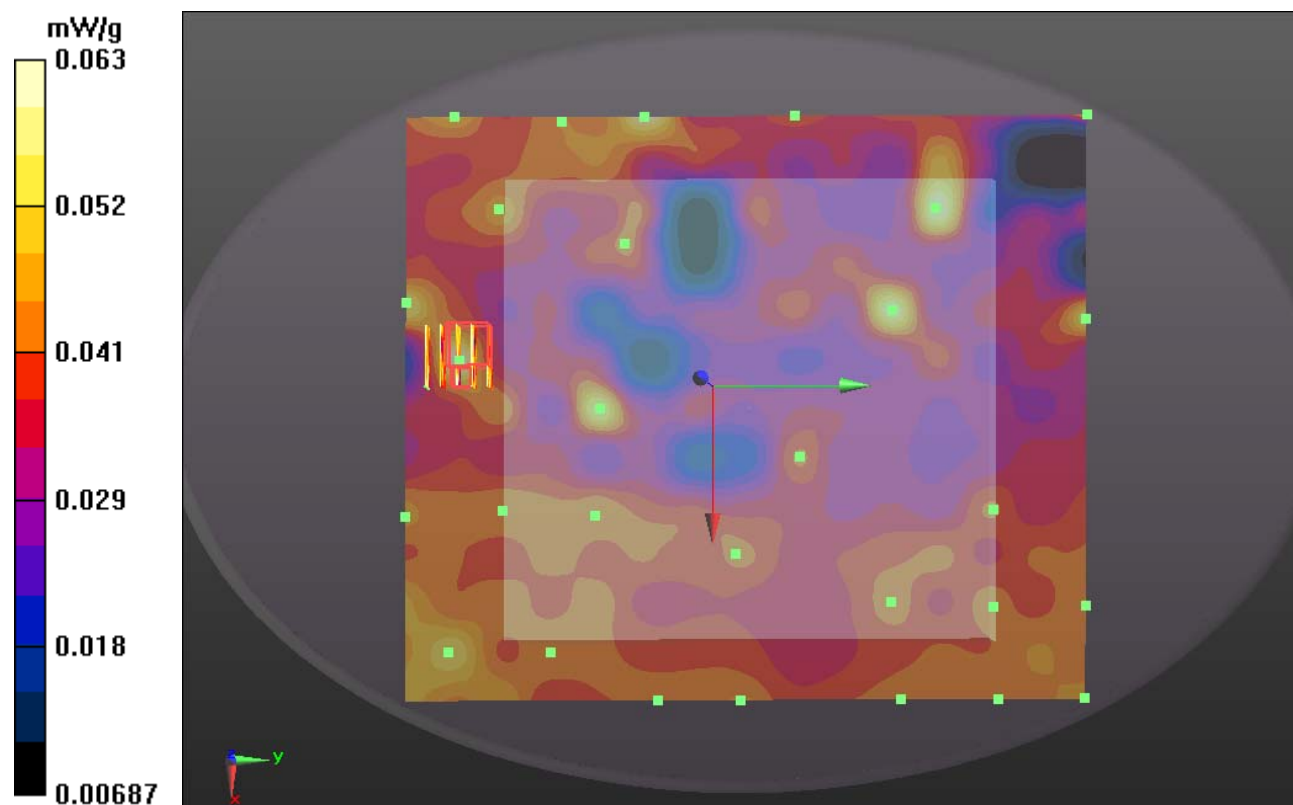

#02 802.11b_Bottom of Laptop_0cm_Ch7_Laptop PC_Ant Degree 180_Sample #1

DUT: 310902B

Communication System: WIFI; Frequency: 2442 MHz; Duty Cycle: 1:1

Medium: HSL_2450_111209 Medium parameters used: $f = 2442$ MHz; $\sigma = 1.817$ mho/m; $\epsilon_r =$

39.689 ; $\rho = 1000$ kg/m³

Ambient Temperature : 23.5 °C ; Liquid Temperature : 21.5 °C

DASY5 Configuration:

- Probe: EX3DV4 - SN3697; ConvF(6.67, 6.67, 6.67); Calibrated: 2011-9-2
- Sensor-Surface: 4mm (Mechanical Surface Detection)
- Electronics: DAE4 Sn1210; Calibrated: 2011-11-18
- Phantom: SAM3; Type: SAM; Serial: TP-1079
- Measurement SW: DASY52, Version 52.6 (2); SEMCAD X Version 14.4.5 (3634)

Ch7/Area Scan (202x202x1): Measurement grid: dx=15mm, dy=15mm

Maximum value of SAR (interpolated) = 0.060 mW/g

Ch7/Zoom Scan (5x5x7)/Cube 0: Measurement grid: dx=8mm, dy=8mm, dz=5mm

Reference Value = 4.836 V/m; Power Drift = -0.01 dB

Peak SAR (extrapolated) = 0.076 W/kg

SAR(1 g) = 0.060 mW/g; SAR(10 g) = 0.051 mW/g

Maximum value of SAR (measured) = 0.076 mW/g

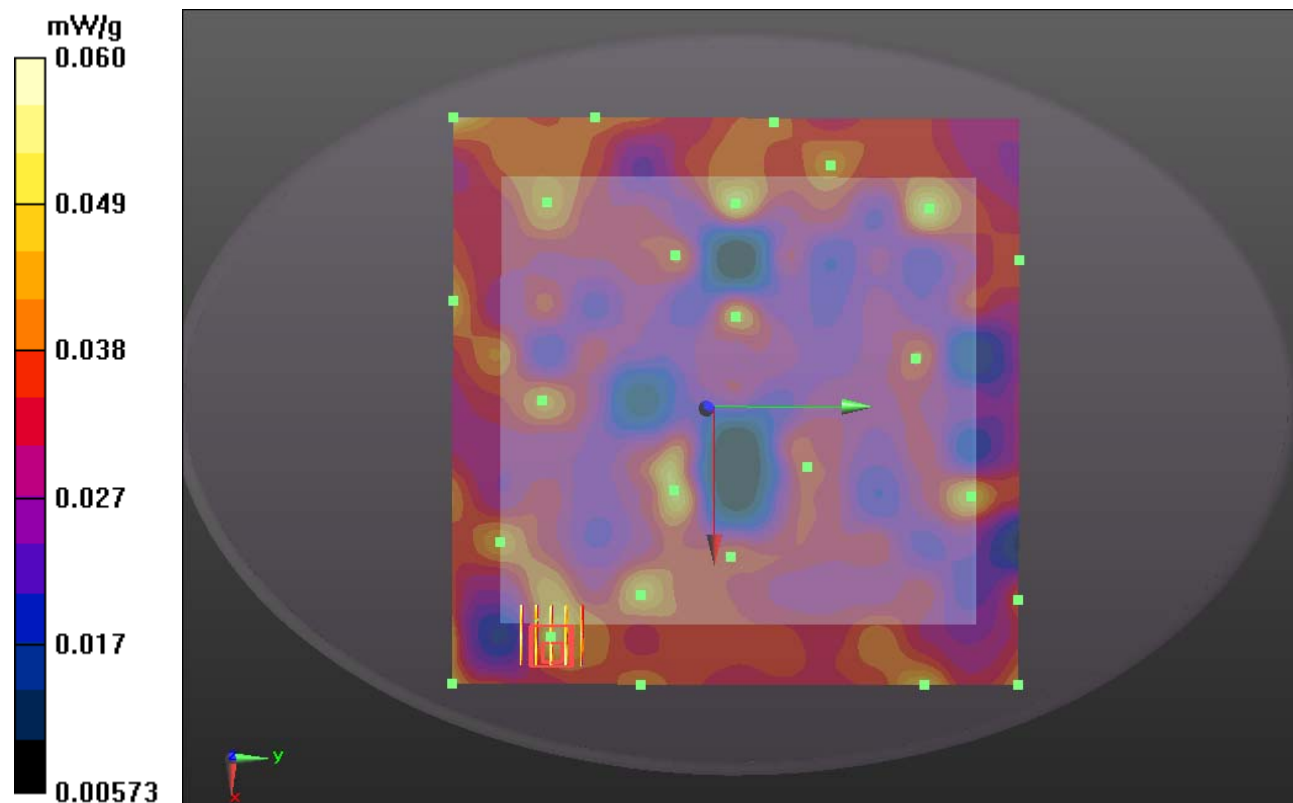

#03 802.11b_Bottom of Tablet_0cm_Ch7_Tablet PC_Ant Degree 0_Sample #1

DUT: 310902B

Communication System: WIFI; Frequency: 2442 MHz; Duty Cycle: 1:1

Medium: HSL_2450_111209 Medium parameters used: $f = 2442$ MHz; $\sigma = 1.817$ mho/m; $\epsilon_r =$

39.689 ; $\rho = 1000$ kg/m³

Ambient Temperature : 23.5 °C ; Liquid Temperature : 21.5 °C

DASY5 Configuration:

- Probe: EX3DV4 - SN3697; ConvF(6.67, 6.67, 6.67); Calibrated: 2011-9-2
- Sensor-Surface: 4mm (Mechanical Surface Detection)
- Electronics: DAE4 Sn1210; Calibrated: 2011-11-18
- Phantom: SAM3; Type: SAM; Serial: TP-1079
- Measurement SW: DASY52, Version 52.6 (2); SEMCAD X Version 14.4.5 (3634)

Ch7/Area Scan (185x202x1): Measurement grid: dx=15mm, dy=15mm

Maximum value of SAR (interpolated) = 0.121 mW/g

Ch7/Zoom Scan (5x5x7)/Cube 0: Measurement grid: dx=8mm, dy=8mm, dz=5mm

Reference Value = 6.495 V/m; Power Drift = 0.04 dB

Peak SAR (extrapolated) = 0.189 W/kg

SAR(1 g) = 0.130 mW/g; SAR(10 g) = 0.105 mW/g

Maximum value of SAR (measured) = 0.189 mW/g

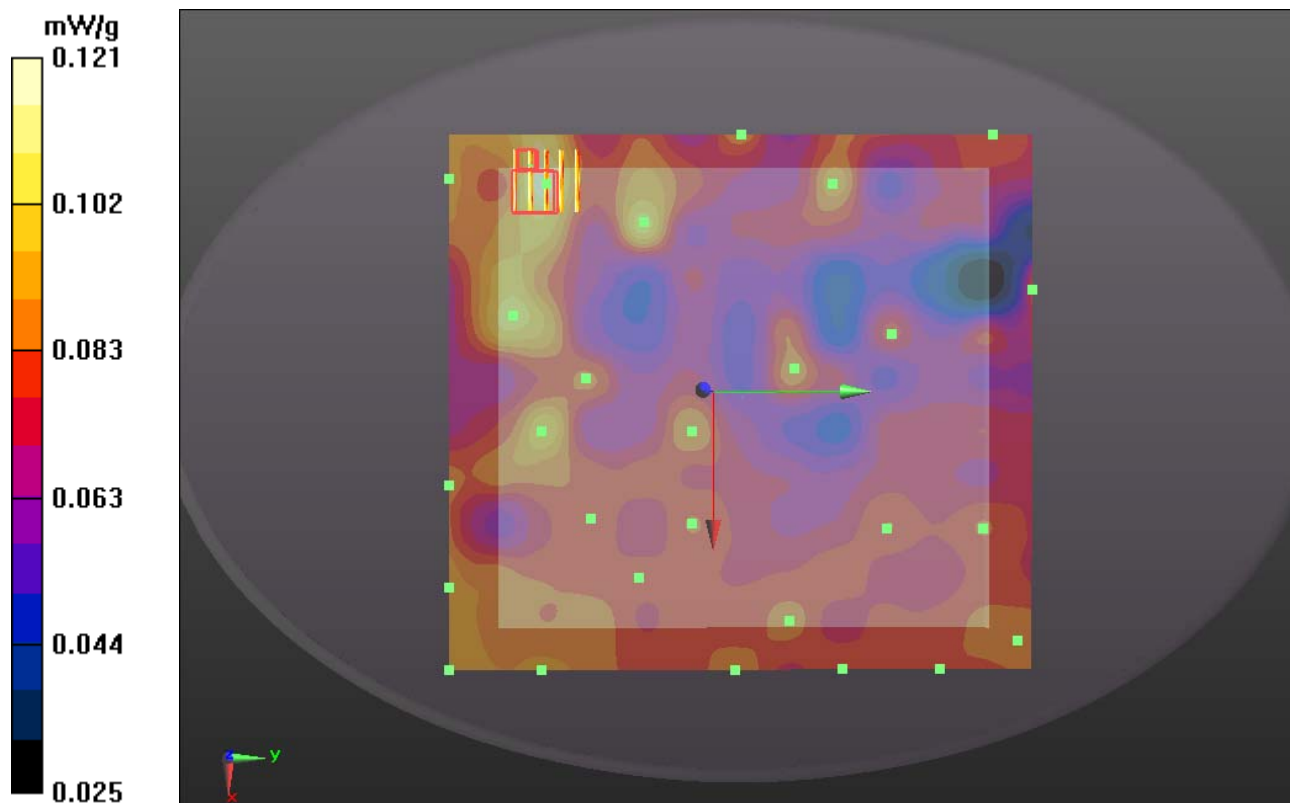

#04 802.11b_Bottom of Tablet_0cm_Ch7_Tablet PC_Ant Degree 180_Sample #1

DUT: 310902B

Communication System: WIFI; Frequency: 2442 MHz; Duty Cycle: 1:1

Medium: HSL_2450_111209 Medium parameters used: $f = 2442$ MHz; $\sigma = 1.817$ mho/m; $\epsilon_r =$

39.689 ; $\rho = 1000$ kg/m³

Ambient Temperature : 23.5 °C ; Liquid Temperature : 21.5 °C

DASY5 Configuration:

- Probe: EX3DV4 - SN3697; ConvF(6.67, 6.67, 6.67); Calibrated: 2011-9-2
- Sensor-Surface: 4mm (Mechanical Surface Detection)
- Electronics: DAE4 Sn1210; Calibrated: 2011-11-18
- Phantom: SAM3; Type: SAM; Serial: TP-1079
- Measurement SW: DASY52, Version 52.6 (2); SEMCAD X Version 14.4.5 (3634)

Ch7/Area Scan (219x202x1): Measurement grid: dx=15mm, dy=15mm

Maximum value of SAR (interpolated) = 0.148 mW/g

Ch7/Zoom Scan (5x5x7)/Cube 0: Measurement grid: dx=8mm, dy=8mm, dz=5mm

Reference Value = 5.981 V/m; Power Drift = 0.05 dB

Peak SAR (extrapolated) = 0.232 W/kg

SAR(1 g) = 0.155 mW/g; SAR(10 g) = 0.128 mW/g

Maximum value of SAR (measured) = 0.184 mW/g

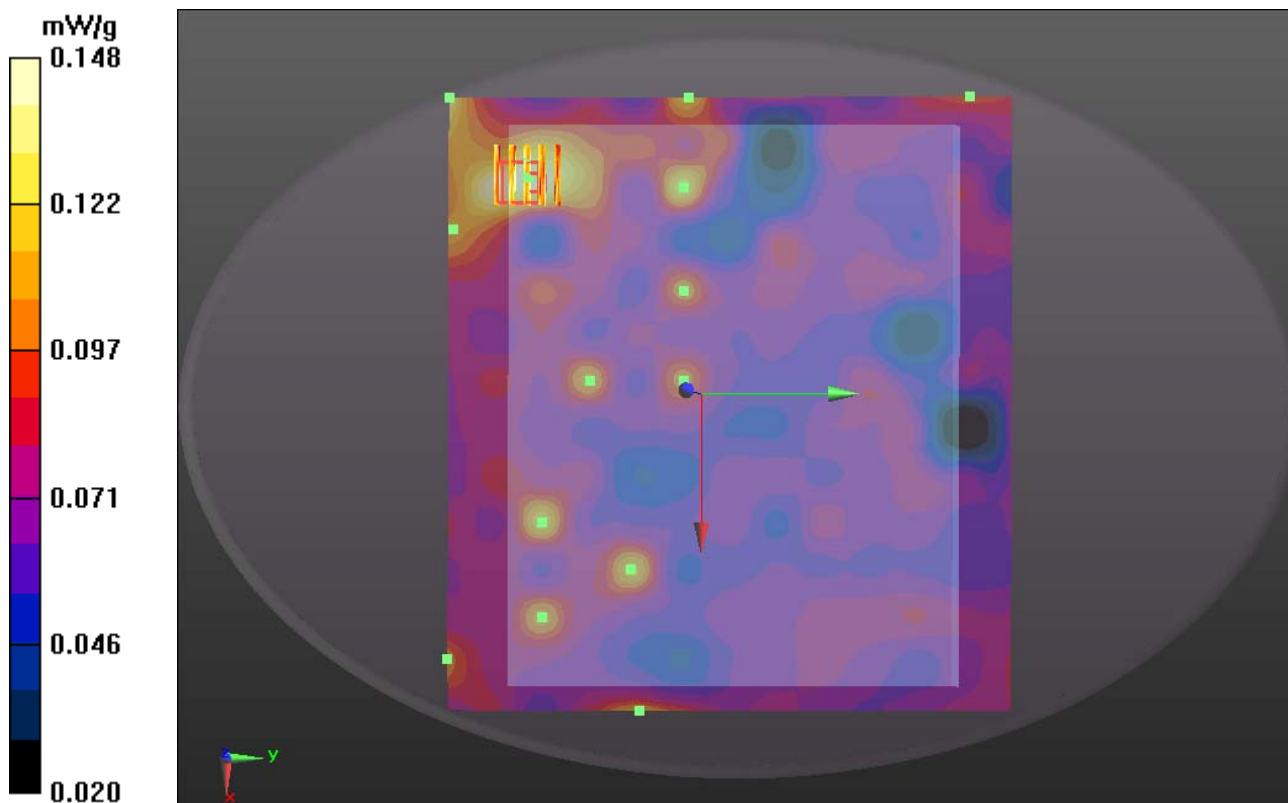

#05 802.11b_Primary Landscape_0cm_Ch7_Tablet PC_Ant Degree 180_Sample #1

DUT: 310902B

Communication System: WIFI; Frequency: 2442 MHz; Duty Cycle: 1:1

Medium: HSL_2450_111209 Medium parameters used: $f = 2442$ MHz; $\sigma = 1.817$ mho/m; $\epsilon_r =$

39.689 ; $\rho = 1000$ kg/m³

Ambient Temperature : 23.5 °C ; Liquid Temperature : 21.5 °C

DASY5 Configuration:

- Probe: EX3DV4 - SN3697; ConvF(6.67, 6.67, 6.67); Calibrated: 2011-9-2
- Sensor-Surface: 4mm (Mechanical Surface Detection)
- Electronics: DAE4 Sn1210; Calibrated: 2011-11-18
- Phantom: SAM3; Type: SAM; Serial: TP-1079
- Measurement SW: DASY52, Version 52.6 (2); SEMCAD X Version 14.4.5 (3634)

Ch7/Area Scan (85x202x1): Measurement grid: dx=15mm, dy=15mm

Maximum value of SAR (interpolated) = 0.023 mW/g

Ch7/Zoom Scan (5x5x7)/Cube 0: Measurement grid: dx=8mm, dy=8mm, dz=5mm

Reference Value = 1.732 V/m; Power Drift = 0.01 dB

Peak SAR (extrapolated) = 0.055 W/kg

SAR(1 g) = 0.016 mW/g; SAR(10 g) = 0.00919 mW/g

Maximum value of SAR (measured) = 0.026 mW/g

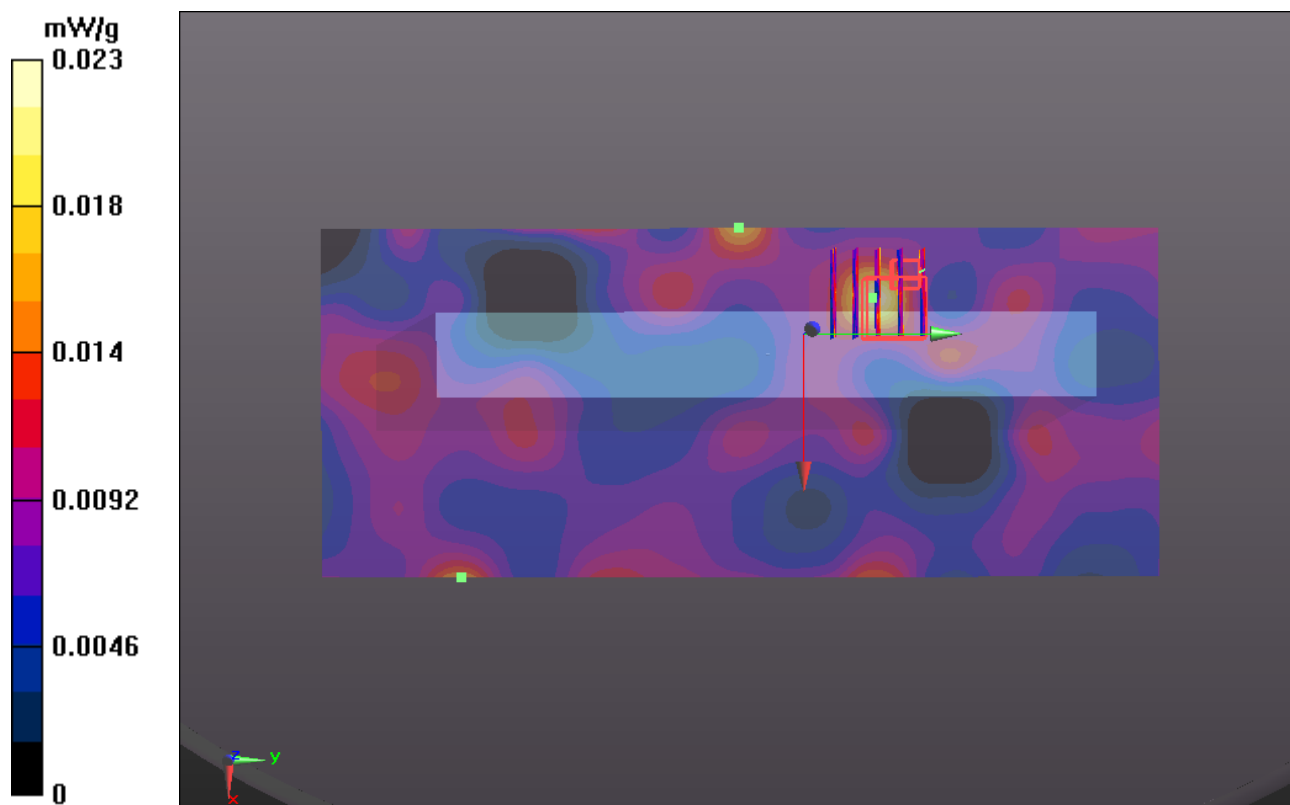

#06 802.11b_Primary Portrait_0cm_Ch7_Tablet PC_Ant Degree 0_Sample #1

DUT: 310902B

Communication System: WIFI; Frequency: 2442 MHz; Duty Cycle: 1:1

Medium: HSL_2450_111209 Medium parameters used: $f = 2442$ MHz; $\sigma = 1.817$ mho/m; $\epsilon_r =$

39.689 ; $\rho = 1000$ kg/m³

Ambient Temperature : 23.5 °C ; Liquid Temperature : 21.5 °C

DASY5 Configuration:

- Probe: EX3DV4 - SN3697; ConvF(6.67, 6.67, 6.67); Calibrated: 2011-9-2
- Sensor-Surface: 4mm (Mechanical Surface Detection)
- Electronics: DAE4 Sn1210; Calibrated: 2011-11-18
- Phantom: SAM3; Type: SAM; Serial: TP-1079
- Measurement SW: DASY52, Version 52.6 (2); SEMCAD X Version 14.4.5 (3634)

Ch7/Area Scan (69x235x1): Measurement grid: dx=15mm, dy=15mm

Maximum value of SAR (interpolated) = 0.880 mW/g

Ch7/Zoom Scan (5x5x7)/Cube 0: Measurement grid: dx=8mm, dy=8mm, dz=5mm

Reference Value = 3.459 V/m; Power Drift = 0.04 dB

Peak SAR (extrapolated) = 2.642 W/kg

SAR(1 g) = 0.925 mW/g; SAR(10 g) = 0.369 mW/g

Maximum value of SAR (measured) = 0.926 mW/g

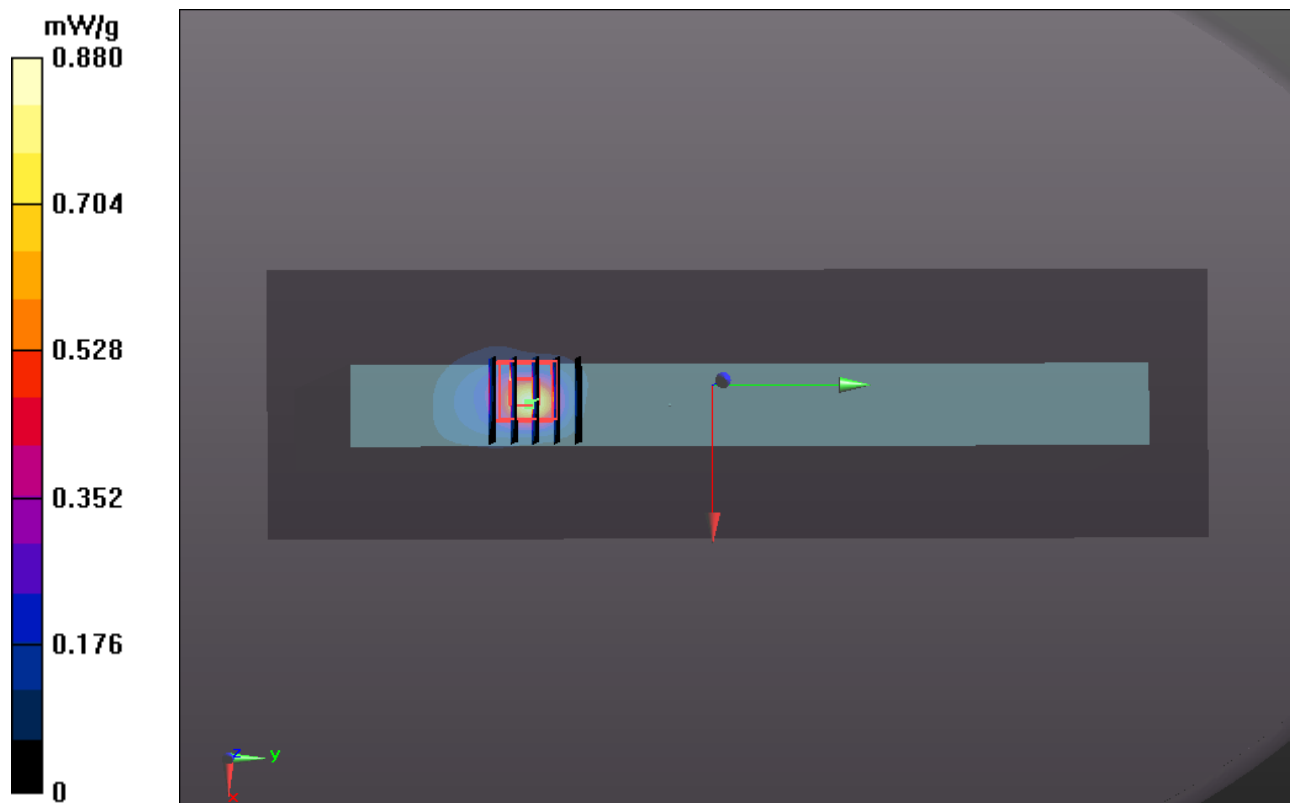

#07 802.11b_Primary Portrait_0cm_Ch7_Tablet PC_Ant Degree 180_Sample #1

DUT: 310902B

Communication System: WIFI; Frequency: 2442 MHz; Duty Cycle: 1:1

Medium: HSL_2450_111209 Medium parameters used: $f = 2442$ MHz; $\sigma = 1.817$ mho/m; $\epsilon_r =$

39.689 ; $\rho = 1000$ kg/m³

Ambient Temperature : 23.5 °C ; Liquid Temperature : 21.5 °C

DASY5 Configuration:

- Probe: EX3DV4 - SN3697; ConvF(6.67, 6.67, 6.67); Calibrated: 2011-9-2
- Sensor-Surface: 4mm (Mechanical Surface Detection)
- Electronics: DAE4 Sn1210; Calibrated: 2011-11-18
- Phantom: SAM3; Type: SAM; Serial: TP-1079
- Measurement SW: DASY52, Version 52.6 (2); SEMCAD X Version 14.4.5 (3634)

Ch7/Area Scan (68x215x1): Measurement grid: dx=15mm, dy=15mm

Maximum value of SAR (interpolated) = 1.321 mW/g

Ch7/Zoom Scan (5x5x7)/Cube 0: Measurement grid: dx=8mm, dy=8mm, dz=5mm

Reference Value = 3.579 V/m; Power Drift = 0.03 dB

Peak SAR (extrapolated) = 3.174 W/kg

SAR(1 g) = 1.29 mW/g; SAR(10 g) = 0.557 mW/g

Maximum value of SAR (measured) = 1.425 mW/g

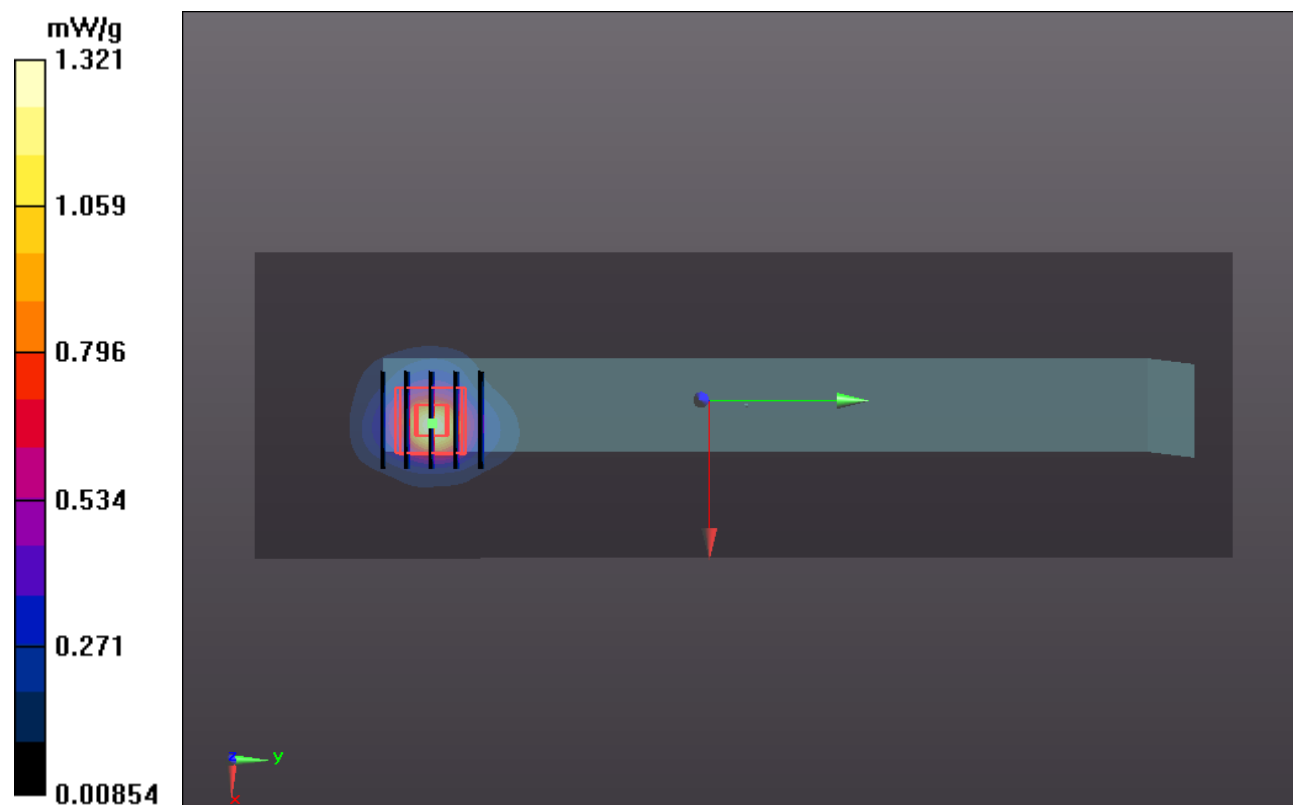

#08 802.11b_Secondary Landscape_0cm_Ch7_Tablet PC_Ant Degree 0_Sample #1

DUT: 310902B

Communication System: WIFI; Frequency: 2442 MHz; Duty Cycle: 1:1

Medium: HSL_2450_111209 Medium parameters used: $f = 2442$ MHz; $\sigma = 1.817$ mho/m; $\epsilon_r =$

39.689 ; $\rho = 1000$ kg/m³

Ambient Temperature : 23.5 °C ; Liquid Temperature : 21.5 °C

DASY5 Configuration:

- Probe: EX3DV4 - SN3697; ConvF(6.67, 6.67, 6.67); Calibrated: 2011-9-2
- Sensor-Surface: 4mm (Mechanical Surface Detection)
- Electronics: DAE4 Sn1210; Calibrated: 2011-11-18
- Phantom: SAM3; Type: SAM; Serial: TP-1079
- Measurement SW: DASY52, Version 52.6 (2); SEMCAD X Version 14.4.5 (3634)

Ch7/Area Scan (85x202x1): Measurement grid: dx=15mm, dy=15mm

Maximum value of SAR (interpolated) = 0.055 mW/g

Ch7/Zoom Scan (5x5x7)/Cube 1: Measurement grid: dx=8mm, dy=8mm, dz=5mm

Reference Value = 2.922 V/m; Power Drift = 0.07 dB

Peak SAR (extrapolated) = 0.056 W/kg

SAR(1 g) = 0.029 mW/g; SAR(10 g) = 0.024 mW/g

Maximum value of SAR (measured) = 0.040 mW/g

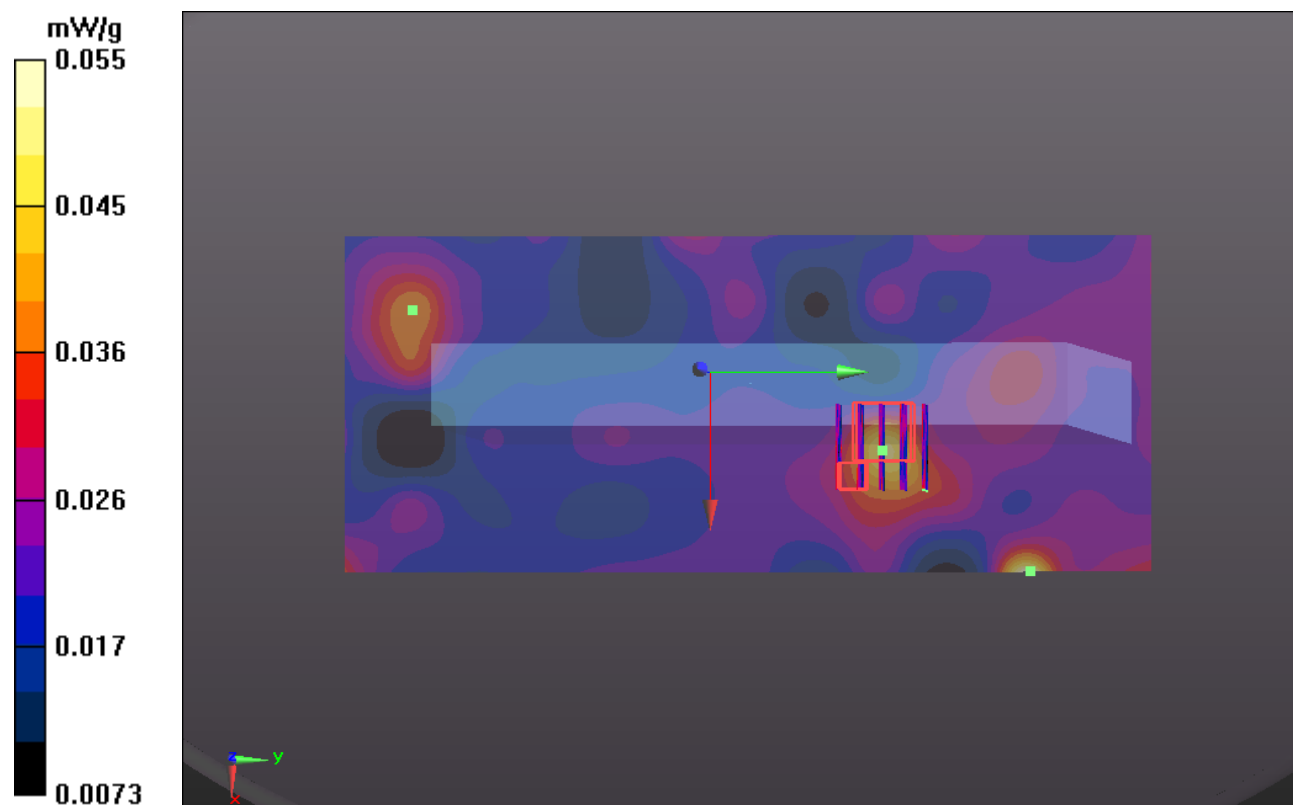

#09 802.11b_Secondary Portrait_0cm_Ch7_Tablet PC_Ant Degree 0_Sample #1

DUT: 310902B

Communication System: WIFI; Frequency: 2442 MHz; Duty Cycle: 1:1

Medium: HSL_2450_111209 Medium parameters used: $f = 2442$ MHz; $\sigma = 1.817$ mho/m; $\epsilon_r =$

39.689 ; $\rho = 1000$ kg/m³

Ambient Temperature : 23.5 °C ; Liquid Temperature : 21.5 °C

DASY5 Configuration:

- Probe: EX3DV4 - SN3697; ConvF(6.67, 6.67, 6.67); Calibrated: 2011-9-2
- Sensor-Surface: 4mm (Mechanical Surface Detection)
- Electronics: DAE4 Sn1210; Calibrated: 2011-11-18
- Phantom: SAM3; Type: SAM; Serial: TP-1079
- Measurement SW: DASY52, Version 52.6 (2); SEMCAD X Version 14.4.5 (3634)

Ch7/Area Scan (69x202x1): Measurement grid: dx=15mm, dy=15mm

Maximum value of SAR (interpolated) = 0.012 mW/g

Ch7/Zoom Scan (5x5x7)/Cube 0: Measurement grid: dx=8mm, dy=8mm, dz=5mm

Reference Value = 2.227 V/m; Power Drift = 0.01 dB

Peak SAR (extrapolated) = 0.020 W/kg

SAR(1 g) = 0.00682 mW/g; SAR(10 g) = 0.00377 mW/g

Maximum value of SAR (measured) = 0.010 mW/g

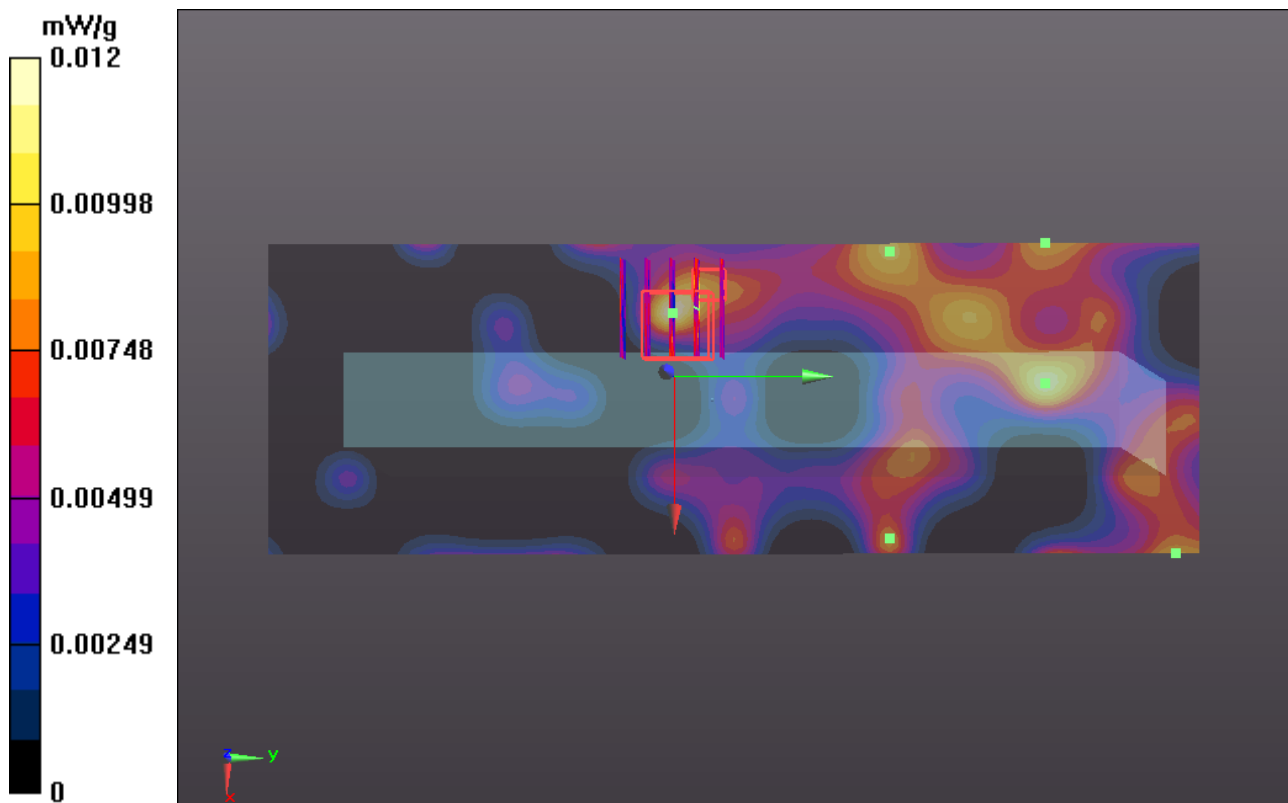

#10 802.11b_Secundary Portrait_0cm_Ch7_Tablet PC_Ant Degree 180_Sample #1

DUT: 310902B

Communication System: WIFI; Frequency: 2442 MHz; Duty Cycle: 1:1

Medium: HSL_2450_111209 Medium parameters used: $f = 2442$ MHz; $\sigma = 1.817$ mho/m; $\epsilon_r =$

39.689 ; $\rho = 1000$ kg/m³

Ambient Temperature : 23.5 °C ; Liquid Temperature : 21.5 °C

DASY5 Configuration:

- Probe: EX3DV4 - SN3697; ConvF(6.67, 6.67, 6.67); Calibrated: 2011-9-2
- Sensor-Surface: 4mm (Mechanical Surface Detection)
- Electronics: DAE4 Sn1210; Calibrated: 2011-11-18
- Phantom: SAM3; Type: SAM; Serial: TP-1079
- Measurement SW: DASY52, Version 52.6 (2); SEMCAD X Version 14.4.5 (3634)

Ch7/Area Scan (69x202x1): Measurement grid: dx=15mm, dy=15mm

Maximum value of SAR (interpolated) = 0.017 mW/g

Ch7/Zoom Scan (5x5x7)/Cube 0: Measurement grid: dx=8mm, dy=8mm, dz=5mm

Reference Value = 1.400 V/m; Power Drift = 0.04 dB

Peak SAR (extrapolated) = 0.024 W/kg

SAR(1 g) = 0.011 mW/g; SAR(10 g) = 0.00707 mW/g

Maximum value of SAR (measured) = 0.015 mW/g

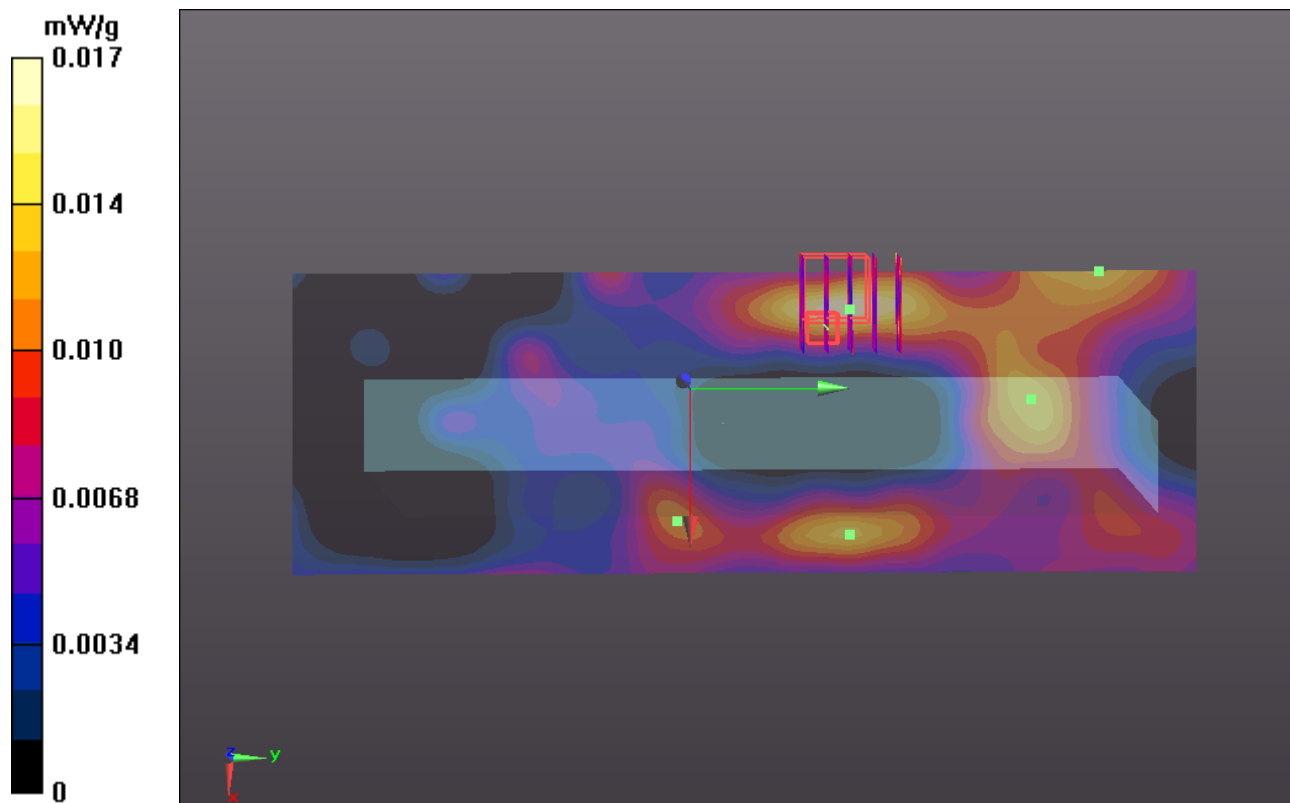

#11 802.11g_Primary Portrait_0cm_Ch7_Tablet PC_Ant Degree 180_Sample #1

DUT: 310902B

Communication System: WIFI; Frequency: 2442 MHz; Duty Cycle: 1:1

Medium: HSL_2450_111209 Medium parameters used: $f = 2442$ MHz; $\sigma = 1.817$ mho/m; $\epsilon_r =$

39.689 ; $\rho = 1000$ kg/m³

Ambient Temperature : 23.5 °C ; Liquid Temperature : 21.5 °C

DASY5 Configuration:

- Probe: EX3DV4 - SN3697; ConvF(6.67, 6.67, 6.67); Calibrated: 2011-9-2
- Sensor-Surface: 4mm (Mechanical Surface Detection)
- Electronics: DAE4 Sn1210; Calibrated: 2011-11-18
- Phantom: SAM3; Type: SAM; Serial: TP-1079
- Measurement SW: DASY52, Version 52.6 (2); SEMCAD X Version 14.4.5 (3634)

Ch7/Area Scan (69x202x1): Measurement grid: dx=15mm, dy=15mm

Maximum value of SAR (interpolated) = 0.550 mW/g

Ch7/Zoom Scan (5x5x7)/Cube 0: Measurement grid: dx=8mm, dy=8mm, dz=5mm

Reference Value = 4.059 V/m; Power Drift = 0.05 dB

Peak SAR (extrapolated) = 1.281 W/kg

SAR(1 g) = 0.505 mW/g; SAR(10 g) = 0.221 mW/g

Maximum value of SAR (measured) = 0.535 mW/g

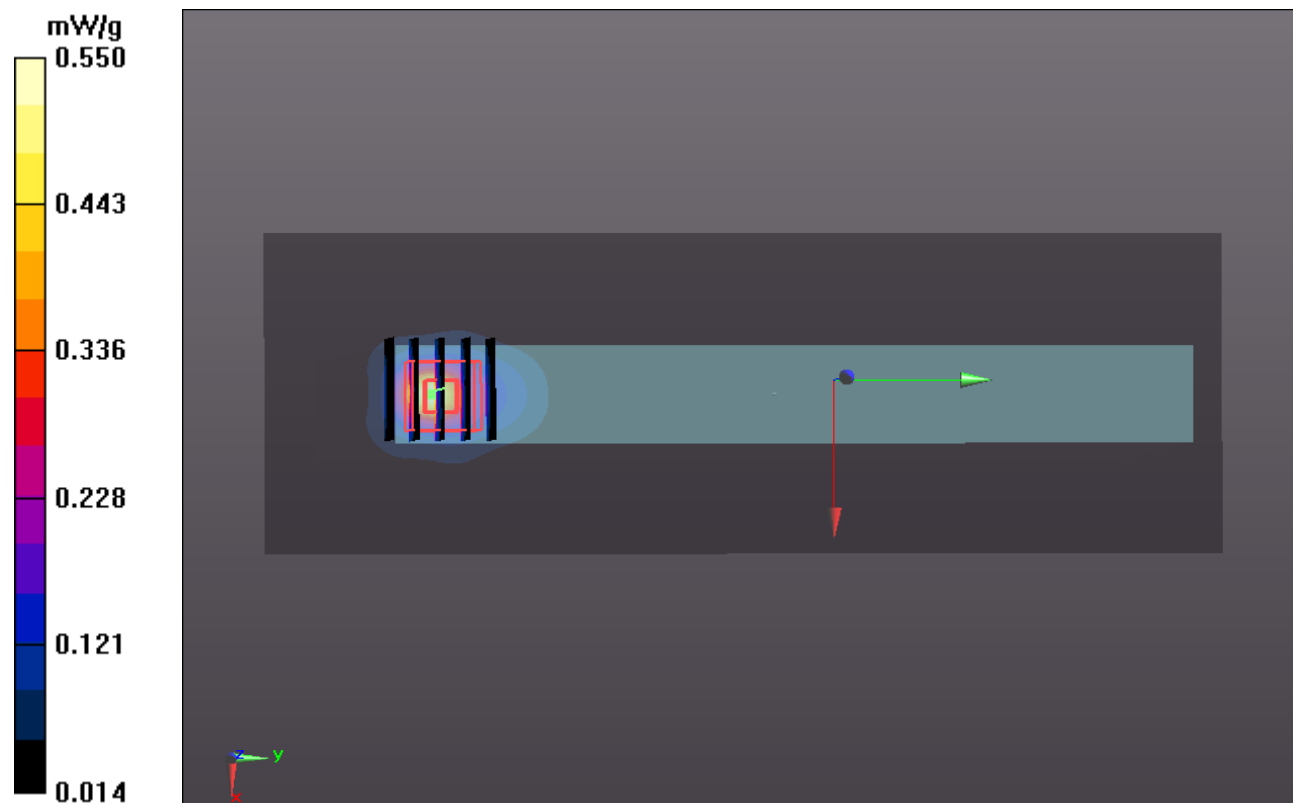

#12 802.11b_Primary Portrait_0cm_Ch1_Tablet PC_Ant Degree 180_Sample #1

DUT: 310902B

Communication System: WIFI; Frequency: 2412 MHz; Duty Cycle: 1:1

Medium: HSL_2450_111209 Medium parameters used: $f = 2412$ MHz; $\sigma = 1.782$ mho/m; $\epsilon_r =$

39.791 ; $\rho = 1000$ kg/m³

Ambient Temperature : 23.5 °C ; Liquid Temperature : 21.5 °C

DASY5 Configuration:

- Probe: EX3DV4 - SN3697; ConvF(6.67, 6.67, 6.67); Calibrated: 2011-9-2
- Sensor-Surface: 4mm (Mechanical Surface Detection)
- Electronics: DAE4 Sn1210; Calibrated: 2011-11-18
- Phantom: SAM3; Type: SAM; Serial: TP-1079
- Measurement SW: DASY52, Version 52.6 (2); SEMCAD X Version 14.4.5 (3634)

Ch1/Area Scan (69x202x1): Measurement grid: dx=15mm, dy=15mm

Maximum value of SAR (interpolated) = 1.080 mW/g

Ch1/Zoom Scan (5x5x7)/Cube 0: Measurement grid: dx=8mm, dy=8mm, dz=5mm

Reference Value = 3.385 V/m; Power Drift = 0.01 dB

Peak SAR (extrapolated) = 3.074 W/kg

SAR(1 g) = 1.22 mW/g; SAR(10 g) = 0.516 mW/g

Maximum value of SAR (measured) = 1.324 mW/g

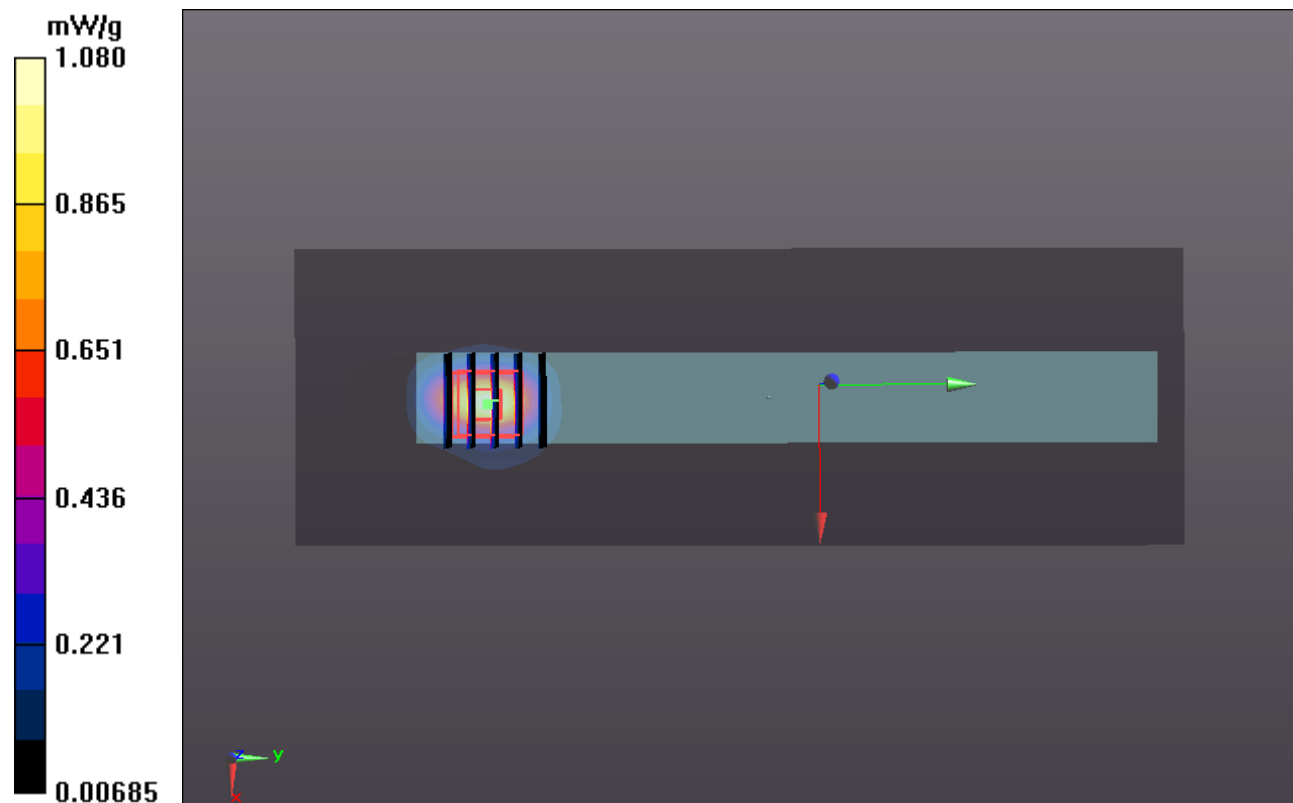

#13 802.11b_Primary Portrait_0cm_Ch13_Tablet PC_Ant Degree 180_Sample #1

DUT: 310902B

Communication System: WIFI; Frequency: 2472 MHz; Duty Cycle: 1:1

Medium: HSL_2450_111209 Medium parameters used: $f = 2472$ MHz; $\sigma = 1.849$ mho/m; $\epsilon_r =$

39.575 ; $\rho = 1000$ kg/m³

Ambient Temperature : 23.5 °C ; Liquid Temperature : 21.5 °C

DASY5 Configuration:

- Probe: EX3DV4 - SN3697; ConvF(6.67, 6.67, 6.67); Calibrated: 2011-9-2
- Sensor-Surface: 4mm (Mechanical Surface Detection)
- Electronics: DAE4 Sn1210; Calibrated: 2011-11-18
- Phantom: SAM3; Type: SAM; Serial: TP-1079
- Measurement SW: DASY52, Version 52.6 (2); SEMCAD X Version 14.4.5 (3634)

Ch13/Area Scan (69x202x1): Measurement grid: dx=15mm, dy=15mm

Maximum value of SAR (interpolated) = 1.324 mW/g

Ch13/Zoom Scan (5x5x7)/Cube 0: Measurement grid: dx=8mm, dy=8mm, dz=5mm

Reference Value = 3.529 V/m; Power Drift = 0.09 dB

Peak SAR (extrapolated) = 3.370 W/kg

SAR(1 g) = 1.33 mW/g; SAR(10 g) = 0.568 mW/g

Maximum value of SAR (measured) = 1.344 mW/g

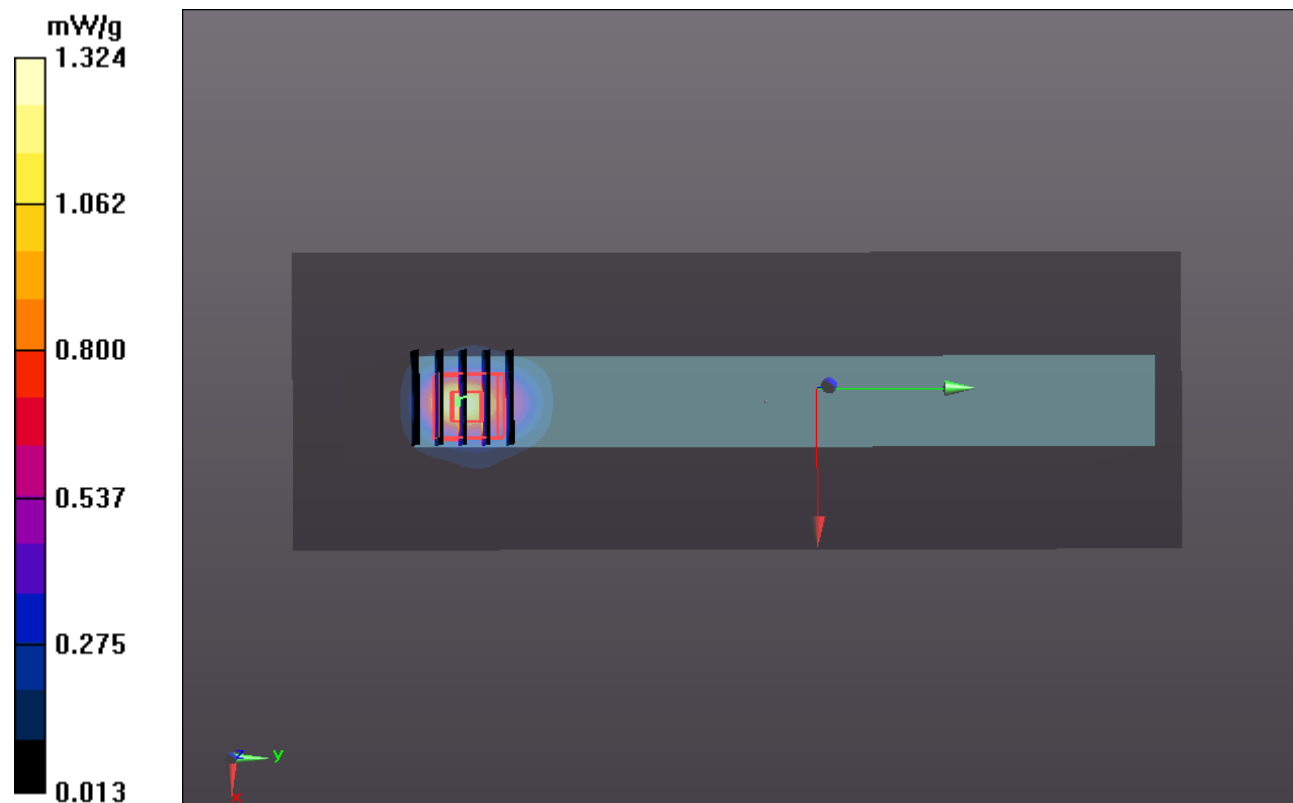

#14 802.11b_Primary Portrait_0cm_Ch13_Tablet PC_Ant Degree 180_Sample #2

DUT: 310902B

Communication System: WIFI; Frequency: 2472 MHz; Duty Cycle: 1:1

Medium: HSL_2450_111209 Medium parameters used: $f = 2472$ MHz; $\sigma = 1.849$ mho/m; $\epsilon_r =$

39.575 ; $\rho = 1000$ kg/m³

Ambient Temperature : 23.3 °C ; Liquid Temperature : 21.5 °C

DASY5 Configuration:

- Probe: EX3DV4 - SN3697; ConvF(6.67, 6.67, 6.67); Calibrated: 2011-9-2
- Sensor-Surface: 4mm (Mechanical Surface Detection)
- Electronics: DAE4 Sn1210; Calibrated: 2011-11-18
- Phantom: SAM3; Type: SAM; Serial: TP-1079
- Measurement SW: DASY52, Version 52.6 (2); SEMCAD X Version 14.4.5 (3634)

Ch13/Area Scan (69x202x1): Measurement grid: dx=15mm, dy=15mm

Maximum value of SAR (interpolated) = 1.040 mW/g

Ch13/Zoom Scan (5x5x7)/Cube 0: Measurement grid: dx=8mm, dy=8mm, dz=5mm

Reference Value = 4.452 V/m; Power Drift = 0.02 dB

Peak SAR (extrapolated) = 3.267 W/kg

SAR(1 g) = 1.35 mW/g; SAR(10 g) = 0.582 mW/g

Maximum value of SAR (measured) = 1.472 mW/g

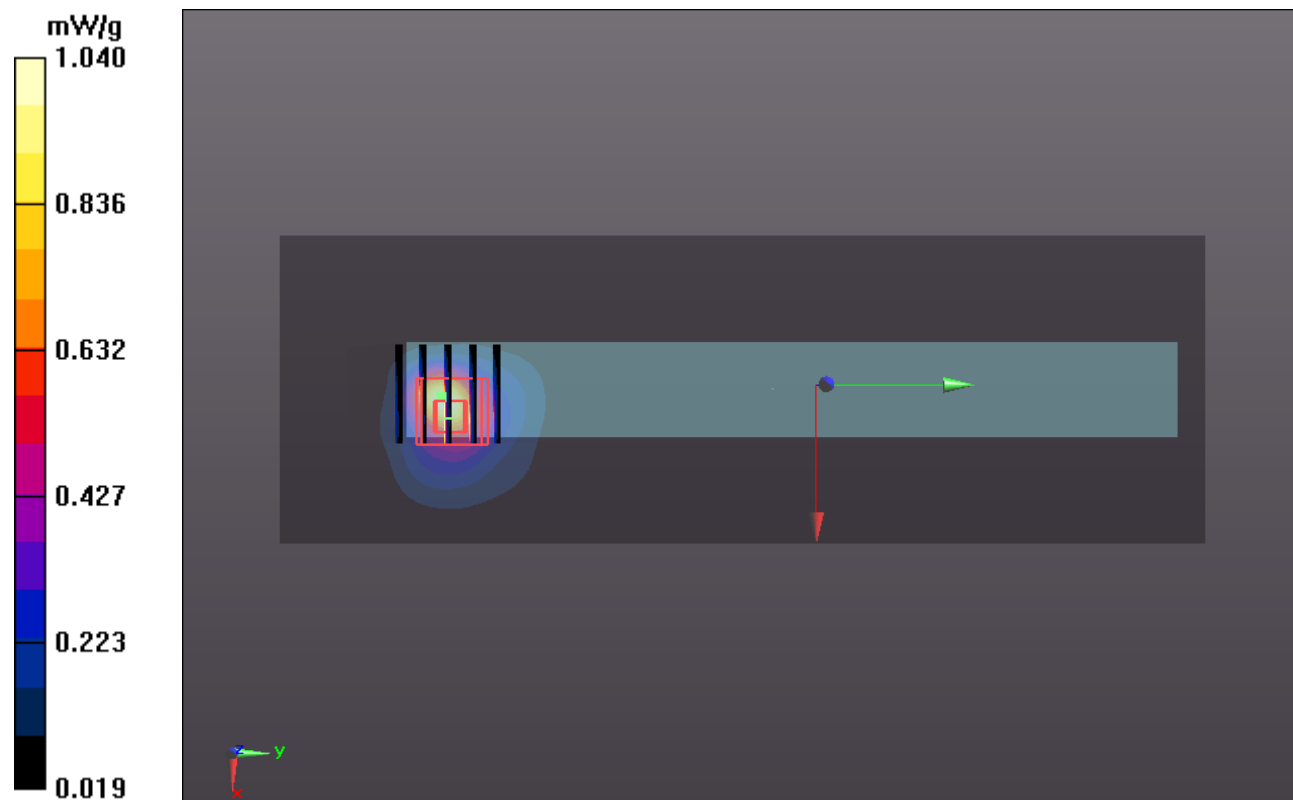



Appendix C. DASY Calibration Certificate

The DASY calibration certificates are shown as follows.



Calibration Laboratory of Schmid & Partner Engineering AG Zeughausstrasse 43, 8004 Zurich, Switzerland



S Schweizerischer Kalibrierdienst
C Service suisse d'etalonnage
S Servizio svizzero di taratura
S Swiss Calibration Service

Accredited by the Swiss Accreditation Service (SAS)
The Swiss Accreditation Service is one of the signatories to the EA Multilateral Agreement for the recognition of calibration certificates

Accreditation No.: SCS 108

Client Sporton (Auden)

Certificate No: D2450V2-840_Mar10

CALIBRATION CERTIFICATE

Object D2450V2 - SN: 840
Calibration procedure(s) QA CAL-05.v7 Calibration procedure for dipole validation kits
Calibration date: March 18, 2010

This calibration certificate documents the traceability to national standards, which realize the physical units of measurements (SI). The measurements and the uncertainties with confidence probability are given on the following pages and are part of the certificate.

All calibrations have been conducted in the closed laboratory facility: environment temperature (22 ± 3)°C and humidity < 70%.

Calibration Equipment used (M&TE critical for calibration)

Table with 4 columns: Primary Standards, ID #, Cal Date (Certificate No.), Scheduled Calibration. Includes rows for Power meter EPM-442A, Power sensor HP 8481A, Reference 20 dB Attenuator, Type-N mismatch combination, Reference Probe ES3DV3, DAE4, Secondary Standards, etc.

Calibrated by: Jeton Kastrati, Laboratory Technician
Approved by: Katja Pokovic, Technical Manager

Handwritten signatures of Jeton Kastrati and Katja Pokovic

Issued: March 22, 2010

This calibration certificate shall not be reproduced except in full without written approval of the laboratory.

**Calibration Laboratory of
Schmid & Partner
Engineering AG**
Zeughausstrasse 43, 8004 Zurich, Switzerland



S Schweizerischer Kalibrierdienst
C Service suisse d'étalonnage
S Servizio svizzero di taratura
S Swiss Calibration Service

Accredited by the Swiss Accreditation Service (SAS)
The Swiss Accreditation Service is one of the signatories to the EA
Multilateral Agreement for the recognition of calibration certificates

Accreditation No.: **SCS 108**

Glossary:

TSL	tissue simulating liquid
ConvF	sensitivity in TSL / NORM x,y,z
N/A	not applicable or not measured

Calibration is Performed According to the Following Standards:

- IEEE Std 1528-2003, "IEEE Recommended Practice for Determining the Peak Spatial-Averaged Specific Absorption Rate (SAR) in the Human Head from Wireless Communications Devices: Measurement Techniques", December 2003
- IEC 62209-1, "Procedure to measure the Specific Absorption Rate (SAR) for hand-held devices used in close proximity to the ear (frequency range of 300 MHz to 3 GHz)", February 2005
- Federal Communications Commission Office of Engineering & Technology (FCC OET), "Evaluating Compliance with FCC Guidelines for Human Exposure to Radiofrequency Electromagnetic Fields; Additional Information for Evaluating Compliance of Mobile and Portable Devices with FCC Limits for Human Exposure to Radiofrequency Emissions", Supplement C (Edition 01-01) to Bulletin 65

Additional Documentation:

- DASY4/5 System Handbook

Methods Applied and Interpretation of Parameters:

- Measurement Conditions:** Further details are available from the Validation Report at the end of the certificate. All figures stated in the certificate are valid at the frequency indicated.
- Antenna Parameters with TSL:** The dipole is mounted with the spacer to position its feed point exactly below the center marking of the flat phantom section, with the arms oriented parallel to the body axis.
- Feed Point Impedance and Return Loss:** These parameters are measured with the dipole positioned under the liquid filled phantom. The impedance stated is transformed from the measurement at the SMA connector to the feed point. The Return Loss ensures low reflected power. No uncertainty required.
- Electrical Delay:** One-way delay between the SMA connector and the antenna feed point. No uncertainty required.
- SAR measured:** SAR measured at the stated antenna input power.
- SAR normalized:** SAR as measured, normalized to an input power of 1 W at the antenna connector.
- SAR for nominal TSL parameters:** The measured TSL parameters are used to calculate the nominal SAR result.



Measurement Conditions

DASY system configuration, as far as not given on page 1.

DASY Version	DASY5	V5.2
Extrapolation	Advanced Extrapolation	
Phantom	Modular Flat Phantom V4.9	
Distance Dipole Center - TSL	10 mm	with Spacer
Zoom Scan Resolution	dx, dy, dz = 5 mm	
Frequency	2450 MHz ± 1 MHz	

Head TSL parameters

The following parameters and calculations were applied.

	Temperature	Permittivity	Conductivity
Nominal Head TSL parameters	22.0 °C	39.2	1.80 mho/m
Measured Head TSL parameters	(22.0 ± 0.2) °C	40.4 ± 6 %	1.80 mho/m ± 6 %
Head TSL temperature during test	(22.0 ± 0.2) °C	----	----

SAR result with Head TSL

SAR averaged over 1 cm ³ (1 g) of Head TSL	Condition	
SAR measured	250 mW input power	13.1 mW / g
SAR normalized	normalized to 1W	52.4 mW / g
SAR for nominal Head TSL parameters	normalized to 1W	52.7 mW /g ± 17.0 % (k=2)

SAR averaged over 10 cm ³ (10 g) of Head TSL	condition	
SAR measured	250 mW input power	6.17 mW / g
SAR normalized	normalized to 1W	24.7 mW / g
SAR for nominal Head TSL parameters	normalized to 1W	24.8 mW /g ± 16.5 % (k=2)



Body TSL parameters

The following parameters and calculations were applied.

	Temperature	Permittivity	Conductivity
Nominal Body TSL parameters	22.0 °C	52.7	1.95 mho/m
Measured Body TSL parameters	(22.0 ± 0.2) °C	54.4 ± 6 %	2.00 mho/m ± 6 %
Body TSL temperature during test	(21.4 ± 0.2) °C	---	---

SAR result with Body TSL

SAR averaged over 1 cm ³ (1 g) of Body TSL	Condition	
SAR measured	250 mW input power	13.1 mW / g
SAR normalized	normalized to 1W	52.4 mW / g
SAR for nominal Body TSL parameters	normalized to 1W	52.1 mW / g ± 17.0 % (k=2)

SAR averaged over 10 cm ³ (10 g) of Body TSL	condition	
SAR measured	250 mW input power	6.13 mW / g
SAR normalized	normalized to 1W	24.5 mW / g
SAR for nominal Body TSL parameters	normalized to 1W	24.5 mW / g ± 16.5 % (k=2)



Appendix

Antenna Parameters with Head TSL

Impedance, transformed to feed point	53.7 Ω + 2.0 j Ω
Return Loss	- 27.9 dB

Antenna Parameters with Body TSL

Impedance, transformed to feed point	49.6 Ω + 3.5 j Ω
Return Loss	- 29.1 dB

General Antenna Parameters and Design

Electrical Delay (one direction)	1.163 ns
----------------------------------	----------

After long term use with 100W radiated power, only a slight warming of the dipole near the feedpoint can be measured.

The dipole is made of standard semirigid coaxial cable. The center conductor of the feeding line is directly connected to the second arm of the dipole. The antenna is therefore short-circuited for DC-signals.

No excessive force must be applied to the dipole arms, because they might bend or the soldered connections near the feedpoint may be damaged.

Additional EUT Data

Manufactured by	SPEAG
Manufactured on	July 20, 2009

DASY5 Validation Report for Head TSL

Date/Time: 18.03.2010 10:23:42

Test Laboratory: SPEAG, Zurich, Switzerland

DUT: Dipole 2450 MHz; Type: D2450V2; Serial: D2450V2 - SN:840

Communication System: CW; Frequency: 2450 MHz; Duty Cycle: 1:1

Medium: HSL U11 BB

Medium parameters used: $f = 2450 \text{ MHz}$; $\sigma = 1.8 \text{ mho/m}$; $\epsilon_r = 40.4$; $\rho = 1000 \text{ kg/m}^3$

Phantom section: Flat Section

Measurement Standard: DASY5 (IEEE/IEC/ANSI C63.19-2007)

DASY5 Configuration:

- Probe: ES3DV3 - SN3205; ConvF(4.53, 4.53, 4.53); Calibrated: 26.06.2009
- Sensor-Surface: 3mm (Mechanical Surface Detection)
- Electronics: DAE4 Sn601; Calibrated: 02.03.2010
- Phantom: Flat Phantom 5.0 (front); Type: QD000P50AA; Serial: 1001
- Measurement SW: DASY5, V5.2 Build 157; SEMCAD X Version 14.0 Build 57

Pin=250 mW /d=10mm, dist=3.0mm (ES-Probe)/Zoom Scan (7x7x7)/Cube 0: Measurement grid: dx=5mm, dy=5mm, dz=5mm

Reference Value = 100 V/m; Power Drift = 0.058 dB

Peak SAR (extrapolated) = 26.5 W/kg

SAR(1 g) = 13.1 mW/g; SAR(10 g) = 6.17 mW/g

Maximum value of SAR (measured) = 16.7 mW/g

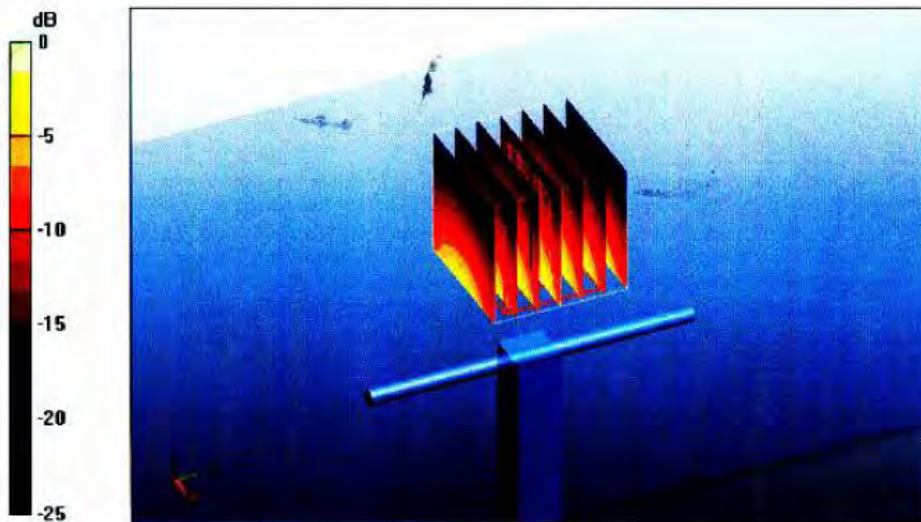

0 dB = 16.7mW/g



Impedance Measurement Plot for Head TSL

18 Mar 2010 10:02:35
[CH1] S11 1 U FS 1: 53.658 Ω 1.9570 Ω 127.13 μH 2 450.000 000 MHz

*
Del
CA
Avg
16

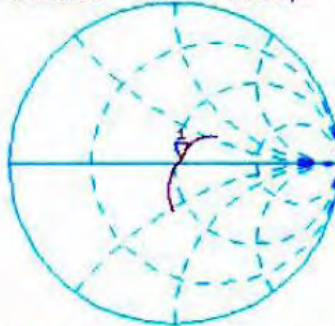

CH2 S11 LOG 5 dB/REF -20 dB 1:-27.948 dB 2 450.000 000 MHz

CA
Avg
16



DASY5 Validation Report for Body

Date/Time: 18.03.2010 12:46:13

Test Laboratory: SPEAG, Zurich, Switzerland

DUT: Dipole 2450 MHz; Type: D2450V2; Serial: D2450V2 - SN:840

Communication System: CW; Frequency: 2450 MHz; Duty Cycle: 1:1

Medium: MSL U11 BB

Medium parameters used: $f = 2450$ MHz; $\sigma = 2.01$ mho/m; $\epsilon_r = 54.5$; $\rho = 1000$ kg/m³

Phantom section: Flat Section

Measurement Standard: DASY5 (IEEE/IEC/ANSI C63.19-2007)

DASY5 Configuration:

- Probe: ES3DV3 - SN3205; ConvF(4.31, 4.31, 4.31); Calibrated: 26.06.2009
- Sensor-Surface: 3mm (Mechanical Surface Detection)
- Electronics: DAE4 Sn601; Calibrated: 02.03.2010
- Phantom: Flat Phantom 5.0 (back); Type: QD000P50AA; Serial: 1002
- Measurement SW: DASY5, V5.2 Build 157; SEMCAD X Version 14.0 Build 57

Pin250 mW /d=10mm, dist=3.0mm (ES-Probe)/Zoom Scan (7x7x7)/Cube 0: Measurement

grid: dx=5mm, dy=5mm, dz=5mm

Reference Value = 95.5 V/m; Power Drift = 0.014 dB

Peak SAR (extrapolated) = 27 W/kg

SAR(1 g) = 13.1 mW/g; SAR(10 g) = 6.13 mW/g

Maximum value of SAR (measured) = 17.3 mW/g

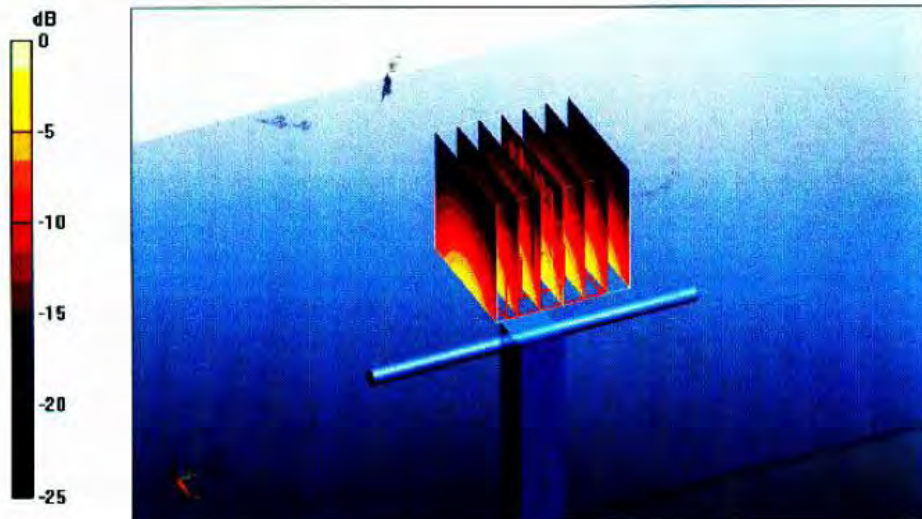

0 dB = 17.3mW/g



Impedance Measurement Plot for Body TSL

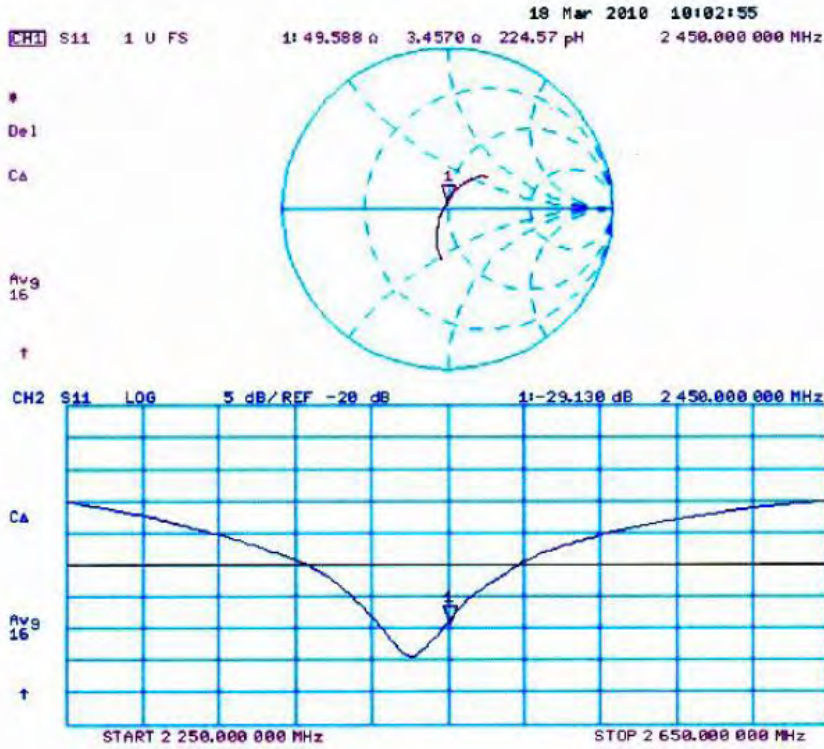



Accredited by the Swiss Accreditation Service (SAS)
The Swiss Accreditation Service is one of the signatories to the EA
Multilateral Agreement for the recognition of calibration certificates

Accreditation No.: **SCS 108**

Client **Sporton CN (Auden)**

Certificate No: **DAE4-1210_Nov11**

CALIBRATION CERTIFICATE

Object **DAE4 - SD 000 D04 BJ - SN: 1210**

Calibration procedure(s) **QA CAL-06.v23
Calibration procedure for the data acquisition electronics (DAE)**

Calibration date: **November 18, 2011**

This calibration certificate documents the traceability to national standards, which realize the physical units of measurements (SI).
The measurements and the uncertainties with confidence probability are given on the following pages and are part of the certificate.

All calibrations have been conducted in the closed laboratory facility: environment temperature (22 ± 3)°C and humidity < 70%.

Calibration Equipment used (M&TE critical for calibration)

Primary Standards	ID #	Cal Date (Certificate No.)	Scheduled Calibration
Keithley Multimeter Type 2001	SN: 0810278	28-Sep-11 (No:11450)	Sep-12
Secondary Standards	ID #	Check Date (in house)	Scheduled Check
Calibrator Box V1.1	SE UMS 006 AB 1004	08-Jun-11 (in house check)	In house check: Jun-12

Calibrated by:	Name Andrea Guntli	Function Technician	Signature
Approved by:	Name Fin Bomholt	Function R&D Director	Signature

Issued: November 18, 2011

This calibration certificate shall not be reproduced except in full without written approval of the laboratory.



Accredited by the Swiss Accreditation Service (SAS)
The Swiss Accreditation Service is one of the signatories to the EA
Multilateral Agreement for the recognition of calibration certificates

Accreditation No.: **SCS 108**

Glossary

DAE data acquisition electronics
Connector angle information used in DASY system to align probe sensor X to the robot coordinate system.

Methods Applied and Interpretation of Parameters

- **DC Voltage Measurement:** Calibration Factor assessed for use in DASY system by comparison with a calibrated instrument traceable to national standards. The figure given corresponds to the full scale range of the voltmeter in the respective range.
- **Connector angle:** The angle of the connector is assessed measuring the angle mechanically by a tool inserted. Uncertainty is not required.
- The following parameters as documented in the Appendix contain technical information as a result from the performance test and require no uncertainty.
 - **DC Voltage Measurement Linearity:** Verification of the Linearity at +10% and -10% of the nominal calibration voltage. Influence of offset voltage is included in this measurement.
 - **Common mode sensitivity:** Influence of a positive or negative common mode voltage on the differential measurement.
 - **Channel separation:** Influence of a voltage on the neighbor channels not subject to an input voltage.
 - **AD Converter Values with inputs shorted:** Values on the internal AD converter corresponding to zero input voltage
 - **Input Offset Measurement:** Output voltage and statistical results over a large number of zero voltage measurements.
 - **Input Offset Current:** Typical value for information; Maximum channel input offset current, not considering the input resistance.
 - **Input resistance:** Typical value for information: DAE input resistance at the connector, during internal auto-zeroing and during measurement.
 - **Low Battery Alarm Voltage:** Typical value for information. Below this voltage, a battery alarm signal is generated.
 - **Power consumption:** Typical value for information. Supply currents in various operating modes.

DC Voltage Measurement

A/D - Converter Resolution nominal

High Range: 1LSB = 6.1 μ V, full range = -100...+300 mV

Low Range: 1LSB = 61nV, full range = -1.....+3mV

DASY measurement parameters: Auto Zero Time: 3 sec; Measuring time: 3 sec

Calibration Factors	X	Y	Z
High Range	404.131 \pm 0.1% (k=2)	404.957 \pm 0.1% (k=2)	405.070 \pm 0.1% (k=2)
Low Range	3.99774 \pm 0.7% (k=2)	3.98274 \pm 0.7% (k=2)	3.99864 \pm 0.7% (k=2)

Connector Angle

Connector Angle to be used in DASY system	68.0 $^{\circ}$ \pm 1 $^{\circ}$
-------------------------------------------	------------------------------------

Appendix

1. DC Voltage Linearity

High Range		Reading (μV)	Difference (μV)	Error (%)
Channel X	+ Input	200005.7	-6.32	-0.00
Channel X	+ Input	20001.20	1.40	0.01
Channel X	- Input	-19997.25	2.05	-0.01
Channel Y	+ Input	199993.7	-8.34	-0.00
Channel Y	+ Input	19998.85	-0.85	-0.00
Channel Y	- Input	-19999.24	0.86	-0.00
Channel Z	+ Input	199997.0	-3.96	-0.00
Channel Z	+ Input	19999.03	-0.47	-0.00
Channel Z	- Input	-19998.10	1.00	-0.01

Low Range		Reading (μV)	Difference (μV)	Error (%)
Channel X	+ Input	1999.9	-0.19	-0.01
Channel X	+ Input	201.19	1.19	0.59
Channel X	- Input	-199.00	1.20	-0.60
Channel Y	+ Input	1999.7	-0.22	-0.01
Channel Y	+ Input	200.05	0.15	0.07
Channel Y	- Input	-200.98	-0.68	0.34
Channel Z	+ Input	1999.9	-0.10	-0.00
Channel Z	+ Input	199.80	-0.10	-0.05
Channel Z	- Input	-199.54	0.26	-0.13

2. Common mode sensitivity

DASY measurement parameters: Auto Zero Time: 3 sec; Measuring time: 3 sec

	Common mode Input Voltage (mV)	High Range Average Reading (μV)	Low Range Average Reading (μV)
Channel X	200	-5.74	-7.76
	- 200	9.09	7.53
Channel Y	200	-5.73	-4.92
	- 200	7.43	6.93
Channel Z	200	12.31	12.18
	- 200	-13.75	-14.25

3. Channel separation

DASY measurement parameters: Auto Zero Time: 3 sec; Measuring time: 3 sec

	Input Voltage (mV)	Channel X (μV)	Channel Y (μV)	Channel Z (μV)
Channel X	200	-	2.68	0.40
Channel Y	200	1.60	-	4.29
Channel Z	200	2.18	0.10	-

4. AD-Converter Values with inputs shorted

DASY measurement parameters: Auto Zero Time: 3 sec; Measuring time: 3 sec

	High Range (LSB)	Low Range (LSB)
Channel X	15945	17150
Channel Y	15956	16019
Channel Z	15867	16444

5. Input Offset Measurement

DASY measurement parameters: Auto Zero Time: 3 sec; Measuring time: 3 sec

Input 10M Ω

	Average (μ V)	min. Offset (μ V)	max. Offset (μ V)	Std. Deviation (μ V)
Channel X	-0.50	-1.63	0.38	0.33
Channel Y	-0.92	-1.95	-0.17	0.36
Channel Z	-2.02	-4.12	-0.96	0.41

6. Input Offset Current

Nominal Input circuitry offset current on all channels: <25fA

7. Input Resistance (Typical values for information)

	Zeroing (kOhm)	Measuring (MOhm)
Channel X	200	200
Channel Y	200	200
Channel Z	200	200

8. Low Battery Alarm Voltage (Typical values for information)

Typical values	Alarm Level (VDC)
Supply (+ Vcc)	+7.9
Supply (- Vcc)	-7.6

9. Power Consumption (Typical values for information)

Typical values	Switched off (mA)	Stand by (mA)	Transmitting (mA)
Supply (+ Vcc)	+0.01	+6	+14
Supply (- Vcc)	-0.01	-8	-9



S
C
S

Schweizerischer Kalibrierdienst
Service suisse d'étalonnage
Servizio svizzero di taratura
Swiss Calibration Service

Accredited by the Swiss Accreditation Service (SAS)
The Swiss Accreditation Service is one of the signatories to the EA
Multilateral Agreement for the recognition of calibration certificates

Accreditation No.: **SCS 108**

Client **Sporton-CN (Auden)**

Certificate No: **EX3-3697_Sep11**

CALIBRATION CERTIFICATE

Object **EX3DV4 - SN:3697**

Calibration procedure(s) **QA CAL-01.v8, QA CAL-14.v3, QA CAL-23.v4, QA CAL-25.v4
Calibration procedure for dosimetric E-field probes**

Calibration date: **September 2, 2011**

This calibration certificate documents the traceability to national standards, which realize the physical units of measurements (SI).
The measurements and the uncertainties with confidence probability are given on the following pages and are part of the certificate.

All calibrations have been conducted in the closed laboratory facility: environment temperature $(22 \pm 3)^\circ\text{C}$ and humidity $< 70\%$.

Calibration Equipment used (M&TE critical for calibration)

Primary Standards	ID	Cal Date (Certificate No.)	Scheduled Calibration
Power meter E4419B	GB41293874	31-Mar-11 (No. 217-01372)	Apr-12
Power sensor E4412A	MY41498087	31-Mar-11 (No. 217-01372)	Apr-12
Reference 3 dB Attenuator	SN: S5054 (3c)	29-Mar-11 (No. 217-01369)	Apr-12
Reference 20 dB Attenuator	SN: S5086 (20b)	29-Mar-11 (No. 217-01367)	Apr-12
Reference 30 dB Attenuator	SN: S5129 (30b)	29-Mar-11 (No. 217-01370)	Apr-12
Reference Probe ES3DV2	SN: 3013	29-Dec-10 (No. ES3-3013_Dec10)	Dec-11
DAE4	SN: 654	3-May-11 (No. DAE4-654_May11)	May-12
Secondary Standards	ID	Check Date (in house)	Scheduled Check
RF generator HP 8648C	US3642U01700	4-Aug-99 (in house check Oct-09)	In house check: Oct-11
Network Analyzer HP 8753E	US37390585	18-Oct-01 (in house check Oct-10)	In house check: Oct-11

	Name	Function	Signature
Calibrated by:	Katja Pokovic	Technical Manager	
Approved by:	Niels Kuster	Quality Manager	

Issued: September 2, 2011

This calibration certificate shall not be reproduced except in full without written approval of the laboratory.



Accredited by the Swiss Accreditation Service (SAS)

The Swiss Accreditation Service is one of the signatories to the EA
Multilateral Agreement for the recognition of calibration certificates

Accreditation No.: **SCS 108**

Glossary:

TSL	tissue simulating liquid
NORM _{x,y,z}	sensitivity in free space
ConvF	sensitivity in TSL / NORM _{x,y,z}
DCP	diode compression point
CF	crest factor (1/duty_cycle) of the RF signal
A, B, C	modulation dependent linearization parameters
Polarization φ	φ rotation around probe axis
Polarization ϑ	ϑ rotation around an axis that is in the plane normal to probe axis (at measurement center), i.e., $\vartheta = 0$ is normal to probe axis

Calibration is Performed According to the Following Standards:

- IEEE Std 1528-2003, "IEEE Recommended Practice for Determining the Peak Spatial-Averaged Specific Absorption Rate (SAR) in the Human Head from Wireless Communications Devices: Measurement Techniques", December 2003
- IEC 62209-1, "Procedure to measure the Specific Absorption Rate (SAR) for hand-held devices used in close proximity to the ear (frequency range of 300 MHz to 3 GHz)", February 2005

Methods Applied and Interpretation of Parameters:

- NORM_{x,y,z}**: Assessed for E-field polarization $\vartheta = 0$ ($f \leq 900$ MHz in TEM-cell; $f > 1800$ MHz: R22 waveguide). NORM_{x,y,z} are only intermediate values, i.e., the uncertainties of NORM_{x,y,z} does not affect the E²-field uncertainty inside TSL (see below *ConvF*).
- NORM(f)_{x,y,z}** = NORM_{x,y,z} * *frequency_response* (see Frequency Response Chart). This linearization is implemented in DASY4 software versions later than 4.2. The uncertainty of the frequency response is included in the stated uncertainty of *ConvF*.
- DCP_{x,y,z}**: DCP are numerical linearization parameters assessed based on the data of power sweep with CW signal (no uncertainty required). DCP does not depend on frequency nor media.
- PAR**: PAR is the Peak to Average Ratio that is not calibrated but determined based on the signal characteristics
- A_{x,y,z}; B_{x,y,z}; C_{x,y,z}; VR_{x,y,z}**: A, B, C are numerical linearization parameters assessed based on the data of power sweep for specific modulation signal. The parameters do not depend on frequency nor media. VR is the maximum calibration range expressed in RMS voltage across the diode.
- ConvF and Boundary Effect Parameters**: Assessed in flat phantom using E-field (or Temperature Transfer Standard for $f \leq 800$ MHz) and inside waveguide using analytical field distributions based on power measurements for $f > 800$ MHz. The same setups are used for assessment of the parameters applied for boundary compensation (alpha, depth) of which typical uncertainty values are given. These parameters are used in DASY4 software to improve probe accuracy close to the boundary. The sensitivity in TSL corresponds to NORM_{x,y,z} * *ConvF* whereby the uncertainty corresponds to that given for *ConvF*. A frequency dependent *ConvF* is used in DASY version 4.4 and higher which allows extending the validity from ± 50 MHz to ± 100 MHz.
- Spherical isotropy (3D deviation from isotropy)**: in a field of low gradients realized using a flat phantom exposed by a patch antenna.
- Sensor Offset**: The sensor offset corresponds to the offset of virtual measurement center from the probe tip (on probe axis). No tolerance required.

Probe EX3DV4

SN:3697

Manufactured: April 22, 2009
Calibrated: September 2, 2011

Calibrated for DASY/EASY Systems
(Note: non-compatible with DASY2 system!)

DASY/EASY - Parameters of Probe: EX3DV4 - SN:3697

Basic Calibration Parameters

	Sensor X	Sensor Y	Sensor Z	Unc (k=2)
Norm ($\mu\text{V}/(\text{V}/\text{m})^2$) ^A	0.47	0.47	0.51	$\pm 10.1\%$
DCP (mV) ^B	96.1	98.5	98.1	

Modulation Calibration Parameters

UID	Communication System Name	PAR		A dB	B dB	C dB	VR mV	Unc ^E (k=2)
10000	CW	0.00	X	0.00	0.00	1.00	109.5	$\pm 2.7\%$
			Y	0.00	0.00	1.00	113.5	
			Z	0.00	0.00	1.00	114.9	

The reported uncertainty of measurement is stated as the standard uncertainty of measurement multiplied by the coverage factor $k=2$, which for a normal distribution corresponds to a coverage probability of approximately 95%.

^A The uncertainties of NormX,Y,Z do not affect the E^2 -field uncertainty inside TSL (see Pages 5 and 6).

^B Numerical linearization parameter: uncertainty not required.

^E Uncertainty is determined using the max. deviation from linear response applying rectangular distribution and is expressed for the square of the field value.

DASY/EASY - Parameters of Probe: EX3DV4 - SN:3697

Calibration Parameter Determined in Head Tissue Simulating Media

f (MHz) ^C	Relative Permittivity ^F	Conductivity (S/m) ^F	ConvF X	ConvF Y	ConvF Z	Alpha	Depth (mm)	Unct. (k=2)
750	41.9	0.89	8.77	8.77	8.77	0.80	0.66	± 12.0 %
835	41.5	0.90	8.45	8.45	8.45	0.78	0.66	± 12.0 %
900	41.5	0.97	8.29	8.29	8.29	0.68	0.73	± 12.0 %
1450	40.5	1.20	8.38	8.38	8.38	0.61	0.74	± 12.0 %
1750	40.1	1.37	7.71	7.71	7.71	0.80	0.61	± 12.0 %
1900	40.0	1.40	7.46	7.46	7.46	0.80	0.60	± 12.0 %
2000	40.0	1.40	7.87	7.87	7.87	0.55	0.72	± 12.0 %
2300	39.5	1.67	7.09	7.09	7.09	0.66	0.64	± 12.0 %
2450	39.2	1.80	6.67	6.67	6.67	0.72	0.64	± 12.0 %
2600	39.0	1.96	6.55	6.55	6.55	0.66	0.68	± 12.0 %
3500	37.9	2.91	6.51	6.51	6.51	0.38	1.04	± 13.1 %
5200	36.0	4.66	4.66	4.66	4.66	0.40	1.80	± 13.1 %
5500	35.6	4.96	4.32	4.32	4.32	0.45	1.80	± 13.1 %
5600	35.5	5.07	4.03	4.03	4.03	0.45	1.80	± 13.1 %
5800	35.3	5.27	4.28	4.28	4.28	0.43	1.80	± 13.1 %

^C Frequency validity of ± 100 MHz only applies for DASY v4.4 and higher (see Page 2), else it is restricted to ± 50 MHz. The uncertainty is the RSS of the ConvF uncertainty at calibration frequency and the uncertainty for the indicated frequency band.

^F At frequencies below 3 GHz, the validity of tissue parameters (ϵ and σ) can be relaxed to ± 10% if liquid compensation formula is applied to measured SAR values. At frequencies above 3 GHz, the validity of tissue parameters (ϵ and σ) is restricted to ± 5%. The uncertainty is the RSS of the ConvF uncertainty for indicated target tissue parameters.

DASY/EASY - Parameters of Probe: EX3DV4- SN:3697

Calibration Parameter Determined in Body Tissue Simulating Media

f (MHz) ^C	Relative Permittivity ^F	Conductivity (S/m) ^F	ConvF X	ConvF Y	ConvF Z	Alpha	Depth (mm)	Unct. (k=2)
750	55.5	0.96	8.79	8.79	8.79	0.80	0.72	± 12.0 %
835	55.2	0.97	8.67	8.67	8.67	0.80	0.69	± 12.0 %
900	55.0	1.05	8.54	8.54	8.54	0.80	0.68	± 12.0 %
1450	54.0	1.30	7.88	7.88	7.88	0.80	0.65	± 12.0 %
1750	53.4	1.49	7.16	7.16	7.16	0.80	0.66	± 12.0 %
1900	53.3	1.52	6.96	6.96	6.96	0.80	0.64	± 12.0 %
2000	53.3	1.52	7.37	7.37	7.37	0.80	0.66	± 12.0 %
2300	52.9	1.81	6.96	6.96	6.96	0.80	0.65	± 12.0 %
2450	52.7	1.95	6.73	6.73	6.73	0.80	0.57	± 12.0 %
2600	52.5	2.16	6.58	6.58	6.58	0.80	0.58	± 12.0 %
3500	51.3	3.31	6.06	6.06	6.06	0.36	1.23	± 13.1 %
5200	49.0	5.30	4.13	4.13	4.13	0.50	1.95	± 13.1 %
5500	48.6	5.65	3.64	3.64	3.64	0.55	1.95	± 13.1 %
5600	48.5	5.77	3.51	3.51	3.51	0.57	1.95	± 13.1 %
5800	48.2	6.00	3.74	3.74	3.74	0.60	1.95	± 13.1 %

^C Frequency validity of ± 100 MHz only applies for DASY v4.4 and higher (see Page 2), else it is restricted to ± 50 MHz. The uncertainty is the RSS of the ConvF uncertainty at calibration frequency and the uncertainty for the indicated frequency band.

^F At frequencies below 3 GHz, the validity of tissue parameters (ϵ and σ) can be relaxed to ± 10% if liquid compensation formula is applied to measured SAR values. At frequencies above 3 GHz, the validity of tissue parameters (ϵ and σ) is restricted to ± 5%. The uncertainty is the RSS of the ConvF uncertainty for indicated target tissue parameters.

Frequency Response of E-Field (TEM-Cell:ifi110 EXX, Waveguide: R22)

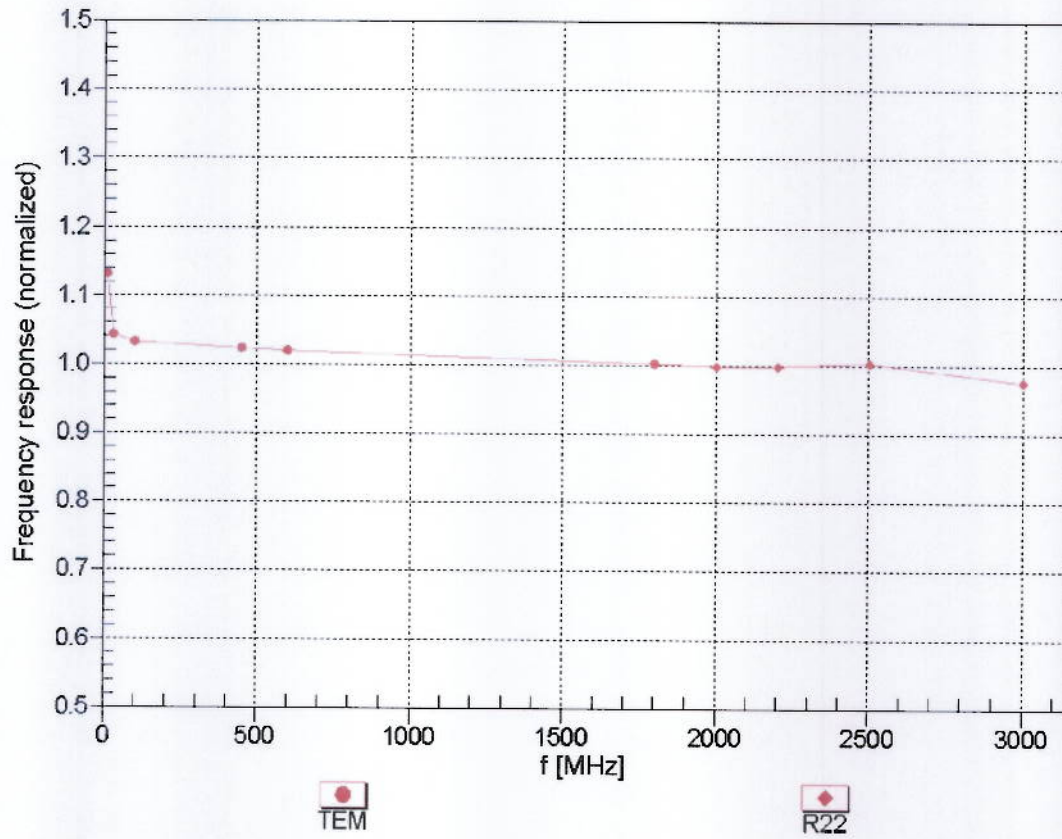

Uncertainty of Frequency Response of E-field: $\pm 6.3\%$ (k=2)

Receiving Pattern (ϕ), $\theta = 0^\circ$

f=600 MHz,TEM

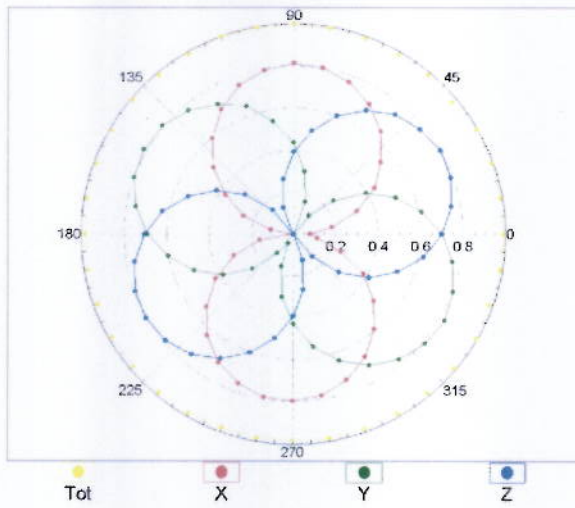

f=1800 MHz,R22

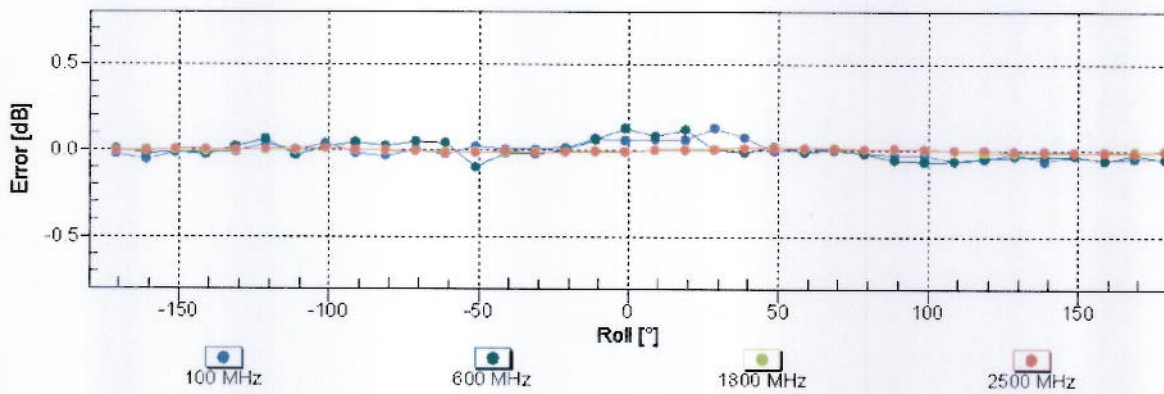
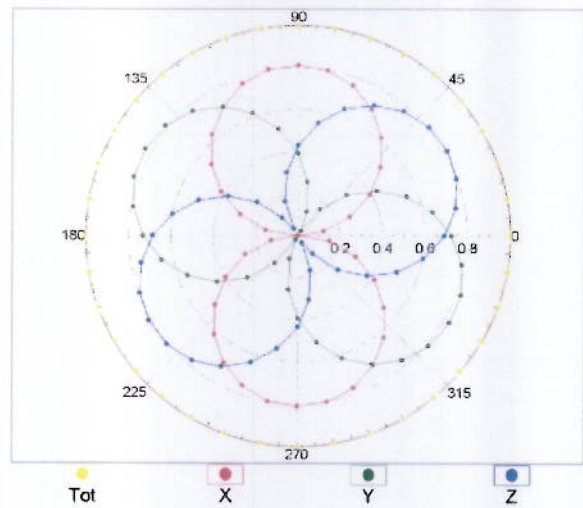

Uncertainty of Axial Isotropy Assessment: $\pm 0.5\%$ (k=2)

Dynamic Range $f(SAR_{head})$ (TEM cell , $f = 900$ MHz)

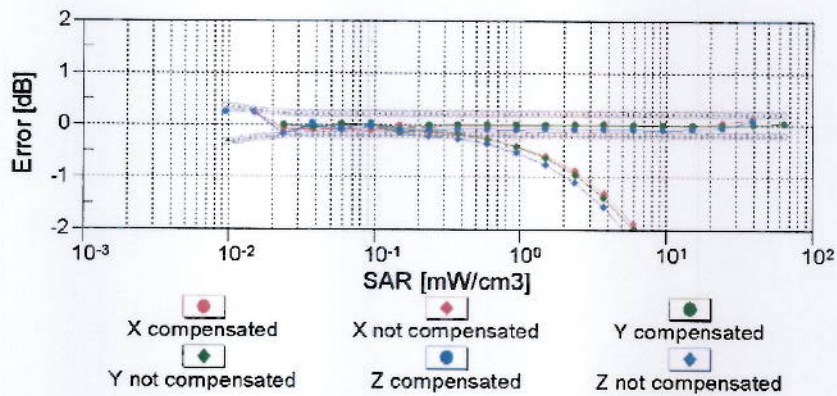
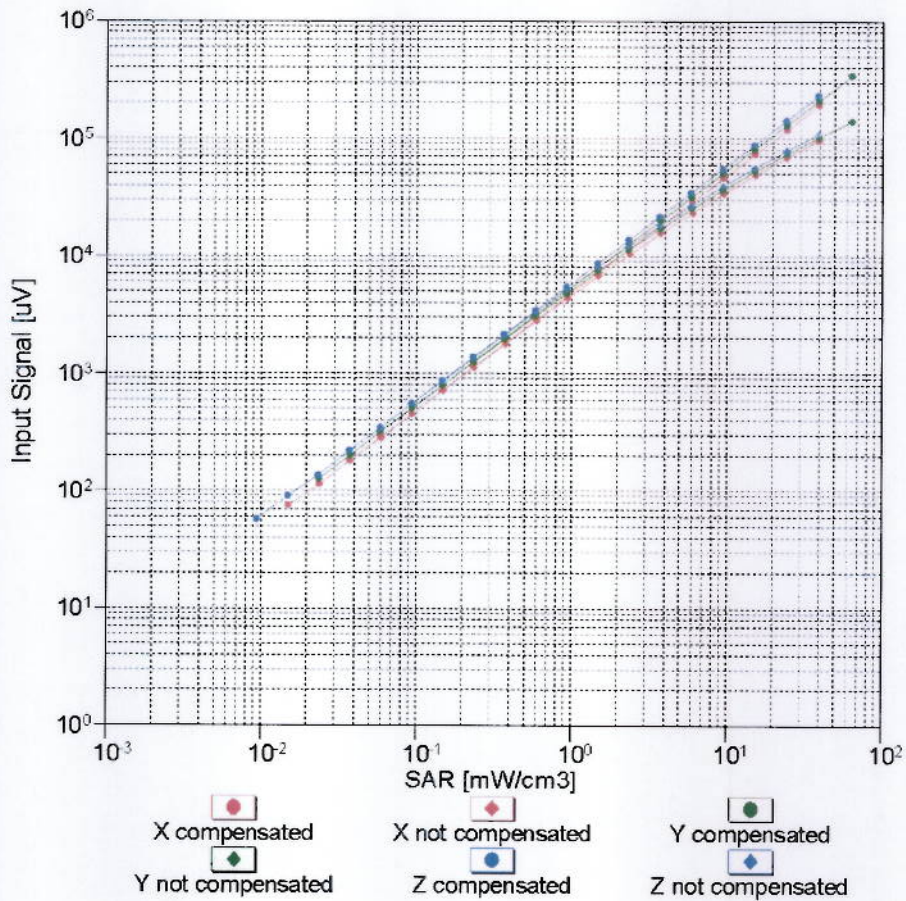

Uncertainty of Linearity Assessment: ± 0.6% (k=2)

Conversion Factor Assessment

f = 835 MHz, WGLS R9 (H_convF)

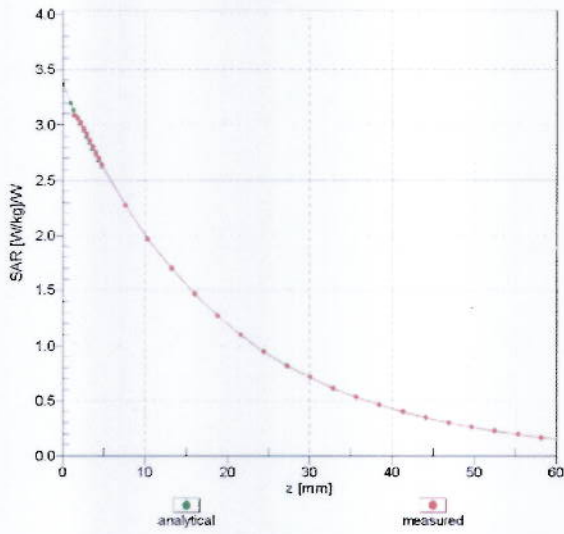

f = 1900 MHz, WGLS R22 (H_convF)

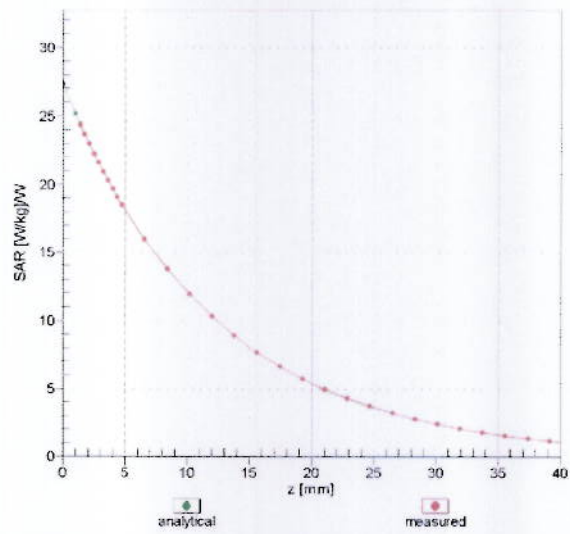

Deviation from Isotropy in Liquid Error (ϕ, θ), f = 900 MHz

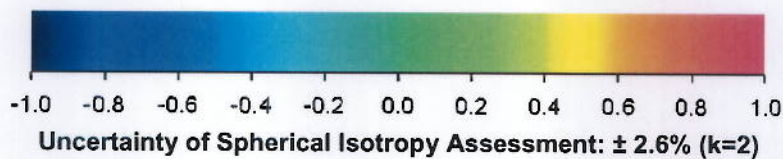
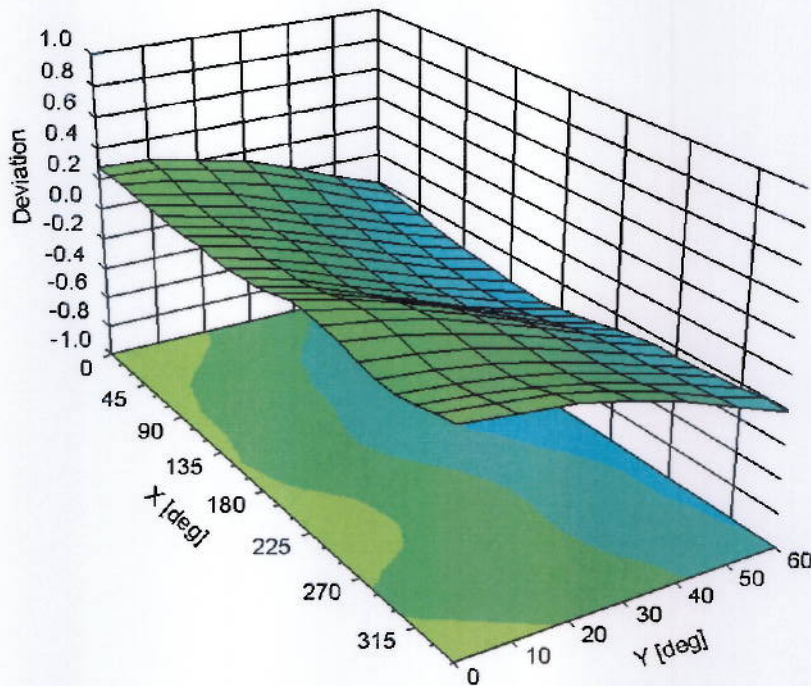

DASY/EASY - Parameters of Probe: EX3DV4 - SN:3697**Other Probe Parameters**

Sensor Arrangement	Triangular
Connector Angle (°)	Not applicable
Mechanical Surface Detection Mode	enabled
Optical Surface Detection Mode	disabled
Probe Overall Length	337 mm
Probe Body Diameter	10 mm
Tip Length	9 mm
Tip Diameter	2.5 mm
Probe Tip to Sensor X Calibration Point	1 mm
Probe Tip to Sensor Y Calibration Point	1 mm
Probe Tip to Sensor Z Calibration Point	1 mm
Recommended Measurement Distance from Surface	2 mm

Appendix C. DASY Calibration Certificate -Extended Dipole Calibrations

Referring to KDB 450824, if dipoles are verified in return loss (<-20dB, within 20% of prior calibration), and in impedance (within 5 ohm of prior calibration), the annual calibration is not necessary and the calibration interval can be extended.

<Dipole Verification Data>- D2450V2, serial no. 840

2450MHz – Head

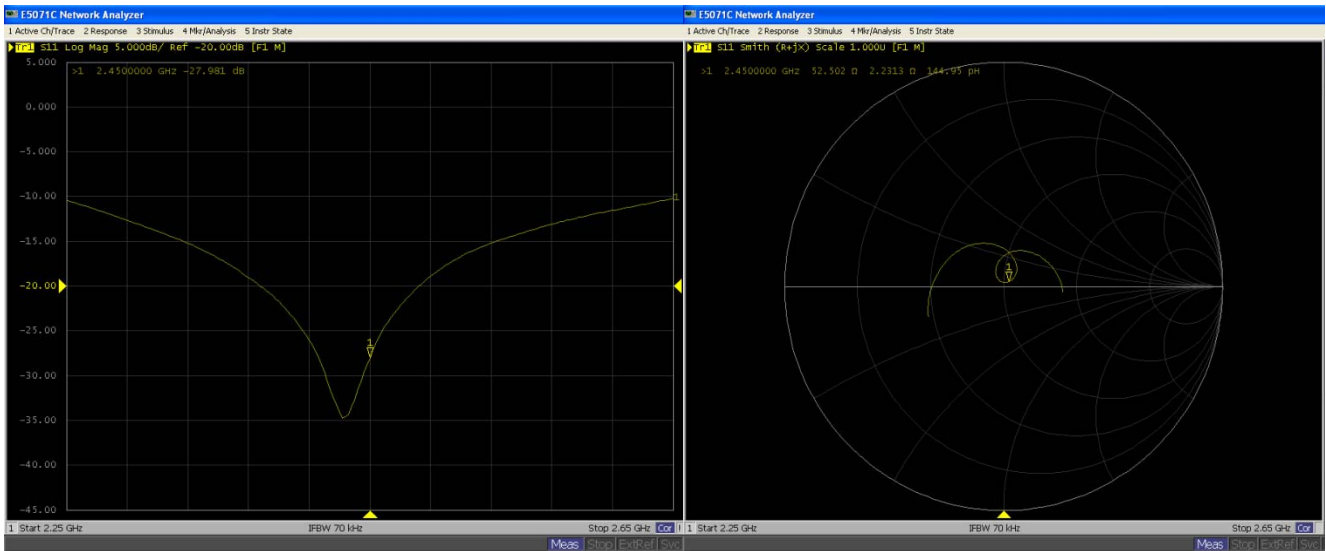

2450MHz - Body

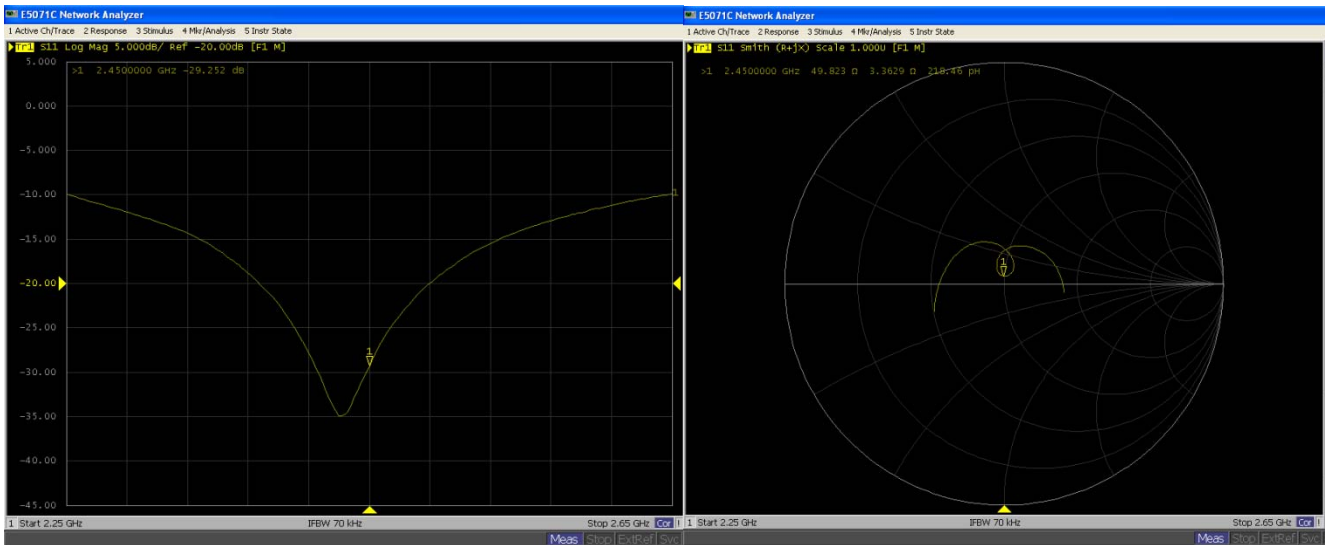



<Justification of the extended calibration>

D2450V2 – serial no. 840												
	2450 Head						2450 Body					
Date of Measurement	Return-Loss (dB)	Delta (%)	Real Impedance (ohm)	Delta (ohm)	Imaginary Impedance (ohm)	Delta (ohm)	Return-Loss (dB)	Delta (%)	Real Impedance (ohm)	Delta (ohm)	Imaginary Impedance (ohm)	Delta (ohm)
03.18.2010	-27.948		53.658		1.957		-29.13		49.588		3.457	
03.17.2011	-27.981	0.033	52.502	1.156	2.2313	0.2743	-29.252	0.122	49.823	0.235	3.3629	0.0941

The return loss is < -20dB, within 20% of prior calibration; the impedance is within 5 ohm of prior calibration. Therefore the verification result should support extended calibration.