



FCC DoC TEST REPORT

REPORT NO.: FD960115L07

MODEL NO.: XO-B2 (Refer to item 3.1 for the more details)

RECEIVED: Jan. 12, 2007

TESTED: Feb. 09 ~ Oct. 05, 2007

ISSUED: Oct. 08, 2007

APPLICANT: OLPC

ADDRESS: 1 Cambridge Center, Cambridge, Massachusetts,
02142 USA

ISSUED BY: Advance Data Technology Corporation

LAB ADDRESS: No. 47, 14th Ling, Chia Pau Tsuen, Lin Kou Hsiang
244, Taipei Hsien, Taiwan, R.O.C.

TEST LOCATION: No. 19, Hwa Ya 2nd Rd., Wen Hwa Tsuen, Kwei
Shan Hsiang, Taoyuan Hsien 333, Taiwan, R.O.C.

This test report consists of 24 pages in total. It may be duplicated completely for legal use with the approval of the applicant. It should not be reproduced except in full, without the written approval of our laboratory. The client should not use it to claim product endorsement by TAF, A2LA or any government agency. The test results in the report only apply to the tested sample.





Table of Contents

1	CERTIFICATION	3
2	SUMMARY OF TEST RESULTS	4
2.1	MEASUREMENT UNCERTAINTY	4
3	GENERAL INFORMATION.....	5
3.1	GENERAL DESCRIPTION OF EUT.....	5
3.2	DESCRIPTION OF TEST MODES.....	6
3.3	DESCRIPTION OF SUPPORT UNITS.....	6
3.4	CONFIGURATION OF SYSTEM UNDER TEST.....	7
4	TEST TYPES AND RESULTS	8
4.1	CONDUCTED EMISSION MEASUREMENT	8
4.1.1	LIMITS OF CONDUCTED EMISSION MEASUREMENT	8
4.1.2	TEST INSTRUMENTS	8
4.1.3	TEST PROCEDURES	9
4.1.4	DEVIATION FROM TEST STANDARD	9
4.1.5	TEST SETUP	9
4.1.6	EUT OPERATING CONDITIONS.....	10
4.1.7	TEST RESULTS	11
4.2	RADIATED EMISSION MEASUREMENT	13
4.2.1	LIMITS OF RADIATED EMISSION MEASUREMENT.....	13
4.2.2	TEST INSTRUMENTS	14
4.2.3	TEST PROCEDURES	15
4.2.4	DEVIATION FROM TEST STANDARD	15
4.2.5	TEST SETUP	16
4.2.6	EUT OPERATING CONDITIONS.....	16
4.2.7	TEST RESULTS	17
5	PHOTOGRAPHS OF THE TEST CONFIGURATION.....	21
6	INFORMATION ON THE TESTING LABORATORIES	23
7	APPENDIX A –MODIFICATION RECORDERS FOR ENGINEERING CHANGES TO THE EUT BY THE LAB	24



1 CERTIFICATION

PRODUCT: Laptop
BRAND: OLPC
MODEL NO.: XO-B2 (Refer to item 3.1 for the more details)
APPLICANT: OLPC
TESTED: Feb. 09 ~ Oct. 05, 2007
TEST SAMPLE: ENGINEERING SAMPLE
STANDARD: **FCC Part 15: 2007, Subpart B, Class B**
CISPR 22: 1997, Class B
ICES-003: 2004, Class B
ANSI C63.4: 2003

The above equipment (model: XO-B2) has been tested by **Advance Data Technology Corporation**, and found compliance with the requirement of the above standards. The test record, data evaluation & Equipment Under Test (EUT) configurations represented herein are true and accurate accounts of the measurements of the sample's EMC characteristics under the conditions specified in this report.

PREPARED BY : Peggy Chen , **DATE :** Oct. 08, 2007
Peggy Chen / Specialist

TECHNICAL
ACCEPTANCE : Antony Lee , **DATE :** Oct. 08, 2007
Responsible for EMI Antony Lee / Supervisor

APPROVED BY : David Liu , **DATE :** Oct. 08, 2007
David Liu / Senior Engineer

2 SUMMARY OF TEST RESULTS

The EUT has been tested according to the following specifications.

EMISSION			
Standard	Test Type	Result	Remarks
FCC Part 15: 2007, Subpart B, Class B CISPR 22: 1997, Class B ICES-003: 2004, Class B	Conducted emission test	PASS	Meet the requirement of limit. Minimum passing margin is -2.60 dB at 0.544 MHz.
	Radiated emission test	PASS	Meet the requirement of limit. Minimum passing margin is -2.56 dB at 968.99 MHz.

Note: The limit for radiated test for 30-1000 MHz was performed according to CISPR 22:1997, which was specified in FCC PART 15 Subpart B 15.109(g). Also the limits of ICES-003:2004 and CISPR 22:1997 are same.

2.1 MEASUREMENT UNCERTAINTY

Where relevant, the following measurement uncertainty levels have been estimated for tests performed on the EUT as specified in CISPR 16-4-2:

Measurement	Frequency	Uncertainty
Conducted emissions	9kHz ~ 30MHz	2.44 dB
	30MHz ~ 200MHz	3.39 dB
Radiated emissions	200MHz ~ 1000MHz	3.43 dB
	1GHz ~ 18GHz	2.26 dB

This uncertainty represents an expanded uncertainty expressed at approximately the 95% confidence level using a coverage factor of k=2.

3 GENERAL INFORMATION

3.1 GENERAL DESCRIPTION OF EUT

PRODUCT	Laptop
MODEL NO.	XO-B2 (Refer to Note 1 for the more details)
POWER SUPPLY	12Vdc from AC adapter
DATA CABLE	NA
POWER CORD	NA
ACCESSORY DEVICES	Adapter

NOTE:

- The models are identical as below to each other, except for their model designation due to marketing requirement.

Model Name	Remark
XO-B2	-
XO***	* mean "-" or "_" or A~Z or 0~9.

- The EUT is powered by the following adapter.

Brand	DELTA ELECTRONICS. INC.
Model	ADP-15PH A
Input Power	100-240Vac, 0.6A, 50-60Hz
Output Power	12Vdc, 1.25A
Power Line	1.8m non-shielded cable with one core

- The above EUT information was declared by manufacturer and for more detailed features description, please refer to the manufacturer's specifications or User's Manual.

3.2 DESCRIPTION OF TEST MODES

The EUT is designed with AC power supply of 100-240V, 50/60Hz. For EMC evaluation, 230Vac/50Hz (for EN 55022), 120Vac/60Hz (for FCC Part 15) had been covered during the pre-test. The worst radiated emission data was founded at **230Vac/50Hz** and recorded in the applied test report.

3.3 DESCRIPTION OF SUPPORT UNITS

The EUT has been tested as an independent unit together with other necessary accessories or support units. The following support units or accessories were used to form a representative test configuration during the tests.

NO.	PRODUCT	BRAND	MODEL NO.	SERIAL NO.	FCC ID
1	KEYBOARD	DELL	SK-8115	MY-OJ4635-71619-548-0464	FCC DoC Approved
2	MOUSE	DELL	M056U0	513021808	FCC DoC Approved
3	MOUSE	DELL	M056U0	349004359	FCC DoC Approved
4	MICROPHONE	Labttec	LVA7313	NA	NA
5	EARPHONE	PHILIPS	SBC HL125	NA	NA
6	WIRELESS AP	corega	CG-WLBARAG2	NA	NA
7	NOTEBOOK	DELL	PP04X	NA	FCC DoC Approved

NO.	SIGNAL CABLE DESCRIPTION OF THE ABOVE SUPPORT UNITS
1	1.8m shielded cable
2	1.8m shielded cable
3	1.8m shielded cable
4	1.8m shielded cable
5	1.8m shielded cable
6	1.8m shielded cable
7	NA

NOTE:

1. All power cords of the above support units are non-shielded (1.8m).
2. Item 6~7 acted as communication partners to transfer data.
3. Item 6~7 were provided by client.

3.4 CONFIGURATION OF SYSTEM UNDER TEST

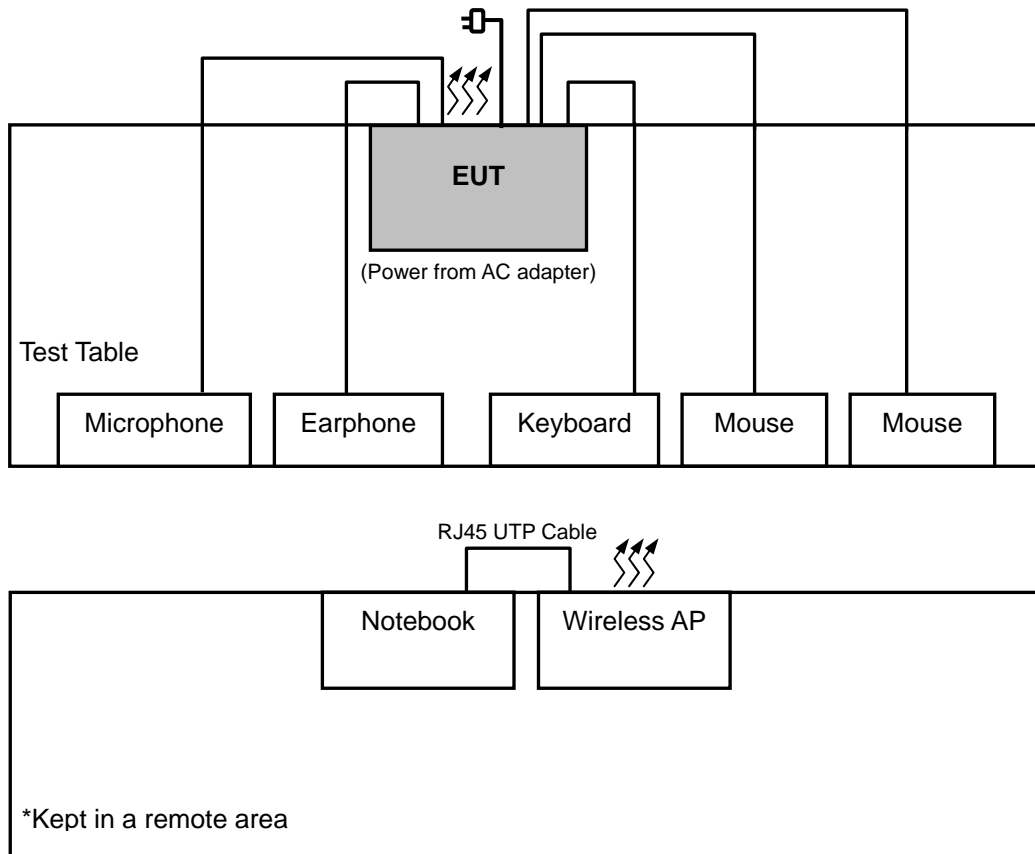



4 TEST TYPES AND RESULTS

4.1 CONDUCTED EMISSION MEASUREMENT

4.1.1 LIMITS OF CONDUCTED EMISSION MEASUREMENT

TEST STANDARD:

FCC Part 15: 2007, Subpart B (Section: 15.107)

CISPR 22: 1997 (section 5)

**ICES-003: 2004 (Class A: section 5.2)
(Class B: section 5.3)**

Frequency (MHz)	Class A (dBuV)		Class B (dBuV)	
	Quasi-peak	Average	Quasi-peak	Average
0.15-0.5	79	66	66-56	56-46
0.5-5	73	60	56	46
5-30	73	60	60	50

- NOTE:**
1. The lower limit shall apply at the transition frequencies.
 2. The limit decreases in line with the logarithm of the frequency in the range of 0.15 to 0.50 MHz.
 3. All emanations from a class A/B digital device or system, including any network of conductors and apparatus connected thereto, shall not exceed the level of field strengths specified above.

4.1.2 TEST INSTRUMENTS

DESCRIPTION & MANUFACTURER	MODEL NO.	SERIAL NO.	CALIBRATED UNTIL
Test Receiver ROHDE & SCHWARZ	ESCS30	100289	Dec. 07, 2007
RF signal cable Woken	5D-FB	Cable-HYC01-01	Jan. 06, 2008
LISN ROHDE & SCHWARZ	ESH3-Z5	100312	Feb. 13, 2008
LISN ROHDE & SCHWARZ	NNBL 8226-2	8226-142	May 07, 2008
Software ADT	ADT_Cond_V3	NA	NA

- NOTE:**
1. The calibration interval of the above test instruments is 12 months and the calibrations are traceable to NML/ROC and NIST/USA.
 2. The test was performed in HwaYa Shielded Room 1.
 3. The VCCI Site Registration No. is C-2040.

4.1.3 TEST PROCEDURES

The basic test procedure was in accordance with ANSI C63.4: 2003 (section 7), CISPR 22 (section 9) and ICES-003:2004 (section 4).

- a. The EUT was placed 0.4 meters from the conducting wall of the shielded room with EUT being connected to the power mains through a line impedance stabilization network (LISN). Other support units were connected to the power mains through another LISN. The two LISNs provide 50 ohm/ 50uH of coupling impedance for the measuring instrument.
- b. Both lines of the power mains connected to the EUT were checked for maximum conducted interference.
- c. The frequency range from 150kHz to 30MHz was searched. Emission levels under Limit - 20dB was not recorded.

4.1.4 DEVIATION FROM TEST STANDARD

No deviation.

4.1.5 TEST SETUP

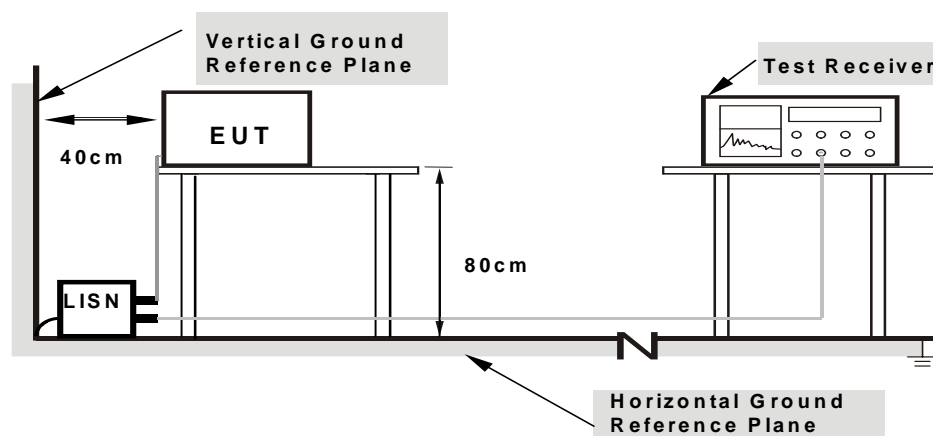

- Note:**
1. Support units were connected to second LISN.
 2. Both of LISNs (AMN) are 80 cm from EUT and at least 80 cm from other units and other metal planes

For the actual test configuration, please refer to the related item – Photographs of the Test Configuration.



4.1.6 EUT OPERATING CONDITIONS

- a. Placed the EUT on the testing table.
- b. The EUT ran a test program to enable EUT under transmission/receiving condition continuously at specific channel frequency.
- c. Prepared a notebook and wireless AP outside of testing area to act as a communication partner.
- d. Sent data to EUT by command "PING" from the communication partner.

4.1.7 TEST RESULTS

INPUT POWER (SYSTEM)	120 Vac, 60 Hz	6dB BANDWIDTH	9 kHz
ENVIRONMENTAL CONDITIONS	24 deg. C, 67% RH, 1006 hPa	PHASE	Line 1
TESTED BY	Ban Hsieh		

No	Freq. [MHz]	Corr. Factor (dB)	Reading Value		Emission Level		Limit		Margin	
			[dB (uV)]		[dB (uV)]		[dB (uV)]		(dB)	
			Q.P.	AV.	Q.P.	AV.	Q.P.	AV.	Q.P.	AV.
1	0.272	0.21	51.00	46.35	51.21	46.56	61.04	51.04	-9.83	-4.48
2	0.545	0.22	47.41	42.44	47.63	42.66	56.00	46.00	-8.37	-3.34
3	0.688	0.22	49.80	40.30	50.02	40.52	56.00	46.00	-5.98	-5.48
4	0.823	0.23	48.15	39.90	48.38	40.13	56.00	46.00	-7.62	-5.87
5	0.959	0.24	45.86	38.09	46.10	38.33	56.00	46.00	-9.90	-7.67
6	1.081	0.24	46.67	41.15	46.91	41.39	56.00	46.00	-9.09	-4.61
7	1.229	0.24	47.48	40.43	47.72	40.67	56.00	46.00	-8.28	-5.33
8	2.153	0.27	46.73	40.06	47.00	40.33	56.00	46.00	-9.00	-5.67
9	2.934	0.32	42.33	-	42.65	-	56.00	46.00	-13.35	-
10	3.563	0.36	41.28	-	41.64	-	56.00	46.00	-14.36	-
11	4.617	0.41	38.75	-	39.16	-	56.00	46.00	-16.84	-

- REMARKS:**
1. Q.P. and AV. are abbreviations of quasi-peak and average individually.
 2. "-": The Quasi-peak reading value also meets average limit and measurement with the average detector is unnecessary.
 3. The emission levels of other frequencies were very low against the limit.
 4. Margin value = Emission level - Limit value
 5. Correction factor = Insertion loss + Cable loss
 6. Emission Level = Correction Factor + Reading Value.

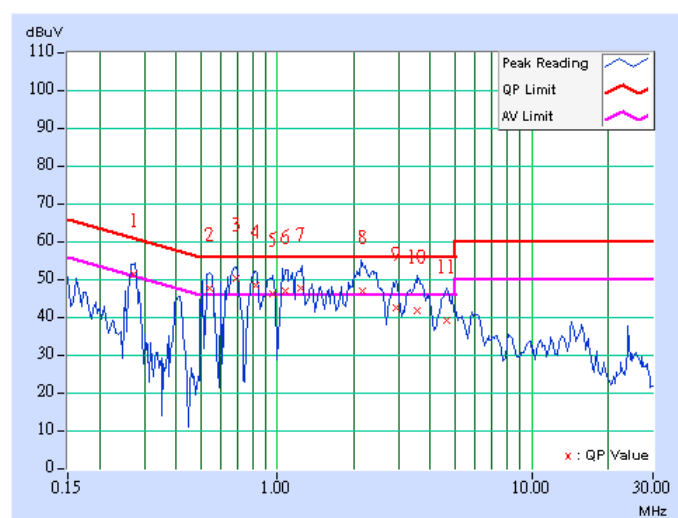

INPUT POWER (SYSTEM)	120 Vac, 60 Hz	6dB BANDWIDTH	9 kHz
ENVIRONMENTAL CONDITIONS	24 deg. C, 67% RH, 1006 hPa	PHASE	Line 2
TESTED BY	Ban Hsieh		

No	Freq. [MHz]	Corr. Factor (dB)	Reading Value		Emission Level		Limit		Margin	
			[dB (uV)]		[dB (uV)]		[dB (uV)]		(dB)	
			Q.P.	AV.	Q.P.	AV.	Q.P.	AV.	Q.P.	AV.
1	0.271	0.21	50.96	47.29	51.17	47.50	61.08	51.08	-9.91	-3.58
2	0.544	0.22	47.86	43.18	48.08	43.40	56.00	46.00	-7.92	-2.60
3	0.686	0.22	49.58	40.73	49.80	40.95	56.00	46.00	-6.20	-5.05
4	0.819	0.23	46.45	40.13	46.68	40.36	56.00	46.00	-9.32	-5.64
5	0.964	0.24	45.76	-	46.00	-	56.00	46.00	-10.00	-
6	1.087	0.24	45.24	-	45.48	-	56.00	46.00	-10.52	-
7	1.235	0.24	47.95	39.39	48.19	39.63	56.00	46.00	-7.81	-6.37
8	2.184	0.27	47.17	39.65	47.44	39.92	56.00	46.00	-8.56	-6.08
9	2.895	0.32	41.64	-	41.96	-	56.00	46.00	-14.04	-
10	3.379	0.35	38.70	-	39.05	-	56.00	46.00	-16.95	-
11	4.609	0.41	38.83	-	39.24	-	56.00	46.00	-16.76	-

- REMARKS:**
1. Q.P. and AV. are abbreviations of quasi-peak and average individually.
 2. "-": The Quasi-peak reading value also meets average limit and measurement with the average detector is unnecessary.
 3. The emission levels of other frequencies were very low against the limit.
 4. Margin value = Emission level - Limit value
 5. Correction factor = Insertion loss + Cable loss
 6. Emission Level = Correction Factor + Reading Value.

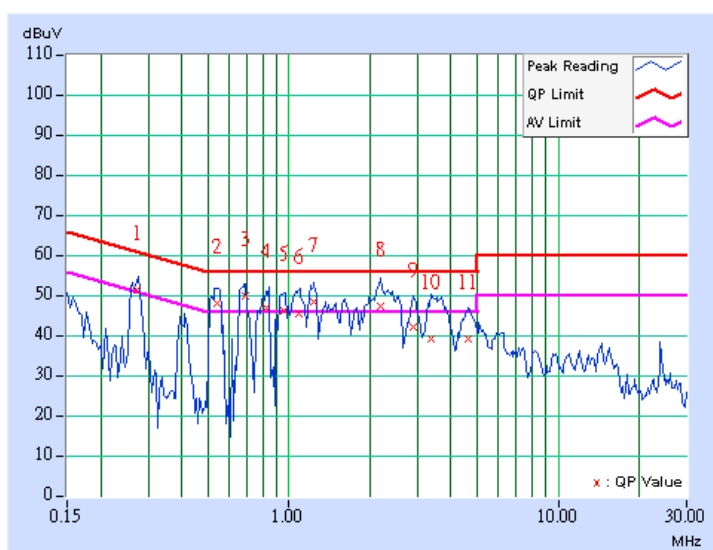



4.2 RADIATED EMISSION MEASUREMENT

4.2.1 LIMITS OF RADIATED EMISSION MEASUREMENT

TEST STANDARD:

FCC Part 15: 2007, Subpart B (Section: 15.109)

CISPR 22: 1997 (section 6)

**ICES-003: 2004 (Class A: section 5.4)
(Class B: section 5.5)**

Frequency (MHz)	Class A (at 10m)	Class B (at 10m)
	Quasi-peak (dBuV/m)	Quasi-peak (dBuV/m)
30-230	40	30
230-1000	47	37

NOTE: The limit for radiated test was performed according to CISPR 22:1997, which was specified in FCC PART 15B 15.109(g). Also the limits of ICES-003:2004 and CISPR 22:1997 are same.

Frequency (MHz)	Class A (at 3m)		Class B (at 3m)	
	Peak (dBuV/m)	Average (dBuV/m)	Peak (dBuV/m)	Average (dBuV/m)
Above 1000	80	60	74	54

- NOTE:**
1. The lower limit shall apply at the transition frequencies.
 2. Emission level (dBuV/m) = 20 log Emission level (uV/m).
 3. All emanations from a class A/B digital device or system, including any network of conductors and apparatus connected thereto, shall not exceed the level of field strengths specified above.

FREQUENCY RANGE OF RADIATED MEASUREMENT (For unintentional radiators)

Highest frequency generated or Upper frequency of measurement used in the device or on which the device operates or tunes (MHz)	Range (MHz)
Below 1.705	30
1.705-108	1000
108-500	2000
500-1000	5000
Above 1000	5th harmonic of the highest frequency or 40 GHz, whichever is lower



4.2.2 TEST INSTRUMENTS

DESCRIPTION & MANUFACTURER	MODEL NO.	SERIAL NO.	CALIBRATED UNTIL
Test Receiver ROHDE & SCHWARZ	ESIB7	100186	Dec. 07, 2007
Test Receiver ROHDE & SCHWARZ	ESIB7	100212	May 07, 2008
Spectrum Analyzer Agilent	8564EC	4208A00662	Dec. 25, 2007
BILOG Antenna SCHWARZBECK	VULB9168	9168-148	Nov. 28, 2007
BILOG Antenna SCHWARZBECK	VULB9168	9168-149	Nov. 28, 2007
HORN Antenna EMCO	3115	5623	Jul. 22, 2008
Preamplifier Agilent	8447D	2944A10637	Dec. 10, 2007
Preamplifier Agilent	8447D	2944A10636	Dec. 10, 2007
Preamplifier Agilent	8449B	3008A01959	Dec. 17, 2007
RF signal cable Woken	8D-FB	Cable-Hych1-01	Oct. 15, 2007
RF signal cable Woken	8D-FB	Cable-Hych1-02	Oct. 15, 2007
RF signal cable HUBER+SUHNER	SUCOFLEX 104	218186/4	Nov. 14, 2007
RF signal cable HUBER+SUHNER	SUCOFLEX 104	204850/4	Nov. 14, 2007
Software ADT	ADT_Radiated_V7	NA	NA
Antenna Tower HD Deisel GmbH	MA240	11030	NA
Antenna Tower HD Deisel GmbH	MA240	12030	NA
Turn Table HD Deisel GmbH	DS430	50303	NA
Controller HD Deisel GmbH	HD2000	18303	NA

NOTE: 1. The calibration interval of the above test instruments is 12 months and the calibrations are traceable to NML/ROC and NIST/USA.

2. The test was performed in HwaYa Chamber 1.
3. The VCCI Site Registration No. is R-1893.
4. The IC Site Registration No. is IC3789B-1.

4.2.3 TEST PROCEDURES

The basic test procedure was in accordance with ANSI C63.4-2003 (section 8), CISPR 22 (section 10) and ICES-003: 2004 (section 4).

- a. The EUT was placed on the top of a rotating table 0.8 meters above the ground at a 10 meters semi-anechoic chamber. The table was rotated 360 degrees to determine the position of the highest radiation.
- b. The EUT was set 10 / 3 meters away from the interference-receiving antenna, which was mounted on the top of a variable-height antenna tower.
- c. The antenna is a broadband antenna, and its height is varied from one meter to four meters above the ground to determine the maximum value of the field strength. Both horizontal and vertical polarizations of the antenna are set to make the measurement.
- d. For each suspected emission, the EUT was arranged to its worst case and then the antenna was tuned to heights from 1 meter to 4 meters and the rotatable table was turned from 0 degrees to 360 degrees to find the maximum reading.
- e. The test-receiver system was set to quasi-peak detect function and specified bandwidth with maximum hold mode when the test frequency is below 1 GHz.

NOTE: The resolution bandwidth and video bandwidth of test receiver/spectrum analyzer is 120 kHz for quasi-peak detection (QP) at frequency below 1 GHz.

4.2.4 DEVIATION FROM TEST STANDARD

No deviation.

4.2.5 TEST SETUP

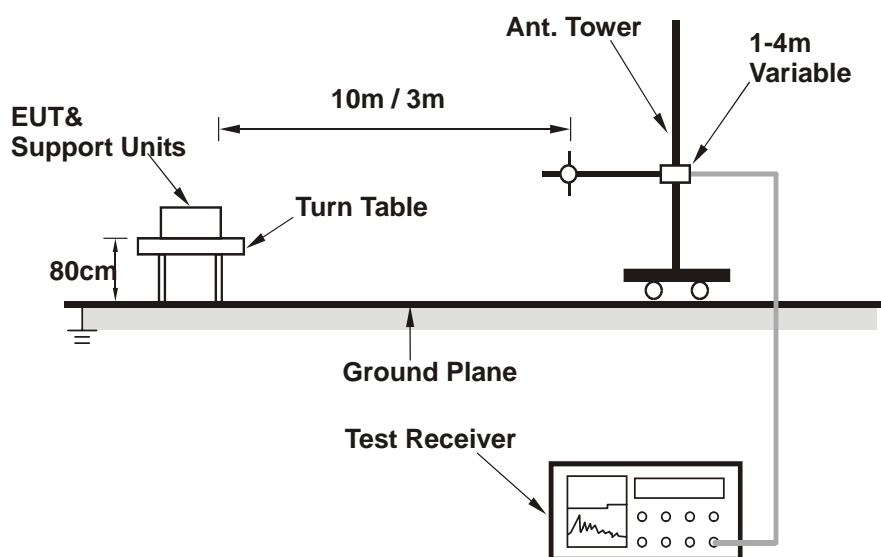

For the actual test configuration, please refer to the related item – Photographs of the Test Configuration.

4.2.6 EUT OPERATING CONDITIONS

Same as 4.1.6.

4.2.7 TEST RESULTS

ENVIRONMENTAL CONDITIONS	23 deg. C, 71% RH, 991 hPa	FREQUENCY RANGE	30-1000 MHz
DETECTOR FUNCTION & BANDWIDTH	Quasi-Peak, 120 kHz	TESTED BY	Skys Huang

ANTENNA POLARITY & TEST DISTANCE: HORIZONTAL AT 10 M								
No.	Freq. (MHz)	Emission Level (dBuV/m)	Limit (dBuV/m)	Margin (dB)	Antenna Height (m)	Table Angle (Degree)	Raw Value (dBuV)	Correction Factor (dB/m)
1	30.05	22.91 QP	30.00	-7.09	1.50 H	34	8.46	14.45
2	134.89	24.34 QP	30.00	-5.66	3.50 H	175	10.93	13.42
3	196.66	23.11 QP	30.00	-6.89	2.50 H	207	11.42	11.69
4	239.88	27.74 QP	37.00	-9.26	4.00 H	260	15.45	12.29
5	257.38	28.70 QP	37.00	-8.30	4.00 H	291	15.30	13.40
6	399.31	27.08 QP	37.00	-9.92	2.50 H	242	8.43	18.65
7	510.14	29.62 QP	37.00	-7.38	2.00 H	103	8.16	21.45
8	552.91	32.22 QP	37.00	-4.78	1.50 H	197	9.80	22.42
9	582.08	31.36 QP	37.00	-5.64	1.50 H	266	8.43	22.93
10	908.72	31.11 QP	37.00	-5.89	1.00 H	224	2.15	28.97
11	968.99	33.04 QP	37.00	-3.96	4.00 H	182	2.55	30.49
12	978.28	31.78 QP	37.00	-5.22	2.50 H	189	1.38	30.40

- REMARKS:**
1. Emission level(dBuV/m)=Raw Value(dBuV) + Correction Factor(dB/m)
 2. Correction Factor(dB/m) = Antenna Factor (dB/m) + Cable Factor (dB)
 3. The other emission levels were very low against the limit.
 4. Margin value = Emission level – Limit value.

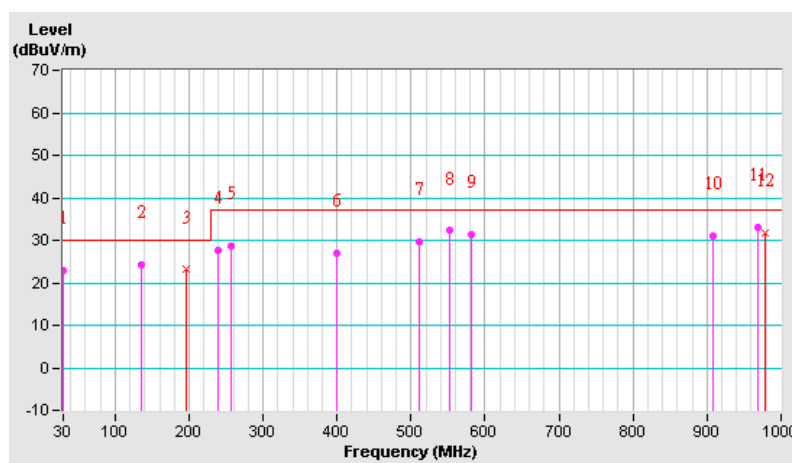

ENVIRONMENTAL CONDITIONS	23 deg. C, 71% RH, 991 hPa	FREQUENCY RANGE	30-1000 MHz
DETECTOR FUNCTION & BANDWIDTH	Quasi-Peak, 120 kHz	TESTED BY	Skys Huang

ANTENNA POLARITY & TEST DISTANCE: VERTICAL AT 10 M								
No.	Freq. (MHz)	Emission Level (dBuV/m)	Limit (dBuV/m)	Margin (dB)	Antenna Height (m)	Table Angle (Degree)	Raw Value (dBuV)	Correction Factor (dB/m)
1	31.84	24.40 QP	30.00	-5.60	2.50 V	312	9.57	14.84
2	37.68	22.51 QP	30.00	-7.49	1.00 V	323	7.63	14.88
3	64.90	21.47 QP	30.00	-8.53	3.00 V	65	7.92	13.55
4	96.01	20.65 QP	30.00	-9.35	2.50 V	2	10.63	10.02
5	142.67	25.07 QP	30.00	-4.93	1.50 V	192	10.46	14.61
6	192.02	25.55 QP	30.00	-4.45	1.00 V	140	13.08	12.47
7	196.64	27.21 QP	30.00	-2.79	1.50 V	50	14.91	12.29
8	210.05	21.35 QP	30.00	-8.65	1.50 V	65	8.97	12.38
9	257.38	30.20 QP	37.00	-6.80	1.00 V	148	16.31	13.89
10	399.31	31.13 QP	37.00	-5.87	4.00 V	176	11.56	19.58
11	552.91	31.06 QP	37.00	-5.94	2.50 V	2	7.50	23.55
12	582.08	31.95 QP	37.00	-5.05	3.00 V	116	7.68	24.27
13	638.46	31.53 QP	37.00	-5.47	2.50 V	151	5.97	25.56
14	665.68	31.91 QP	37.00	-5.09	2.50 V	324	6.09	25.83
15	694.85	29.75 QP	37.00	-7.25	2.00 V	241	3.90	25.85
16	737.62	30.02 QP	37.00	-6.98	2.50 V	316	1.95	28.07
17	850.39	32.16 QP	37.00	-4.84	2.00 V	342	2.44	29.72
18	908.72	31.58 QP	37.00	-5.42	3.50 V	2	1.01	30.57
19	968.99	34.44 QP	37.00	-2.56	1.50 V	2	2.42	32.02
20	978.26	33.65 QP	37.00	-3.35	1.50 V	340	1.71	31.94

- REMARKS:**
1. Emission level(dBuV/m)=Raw Value(dBuV) + Correction Factor(dB/m)
 2. Correction Factor(dB/m) = Antenna Factor (dB/m) + Cable Factor (dB)
 3. The other emission levels were very low against the limit.
 4. Margin value = Emission level – Limit value.

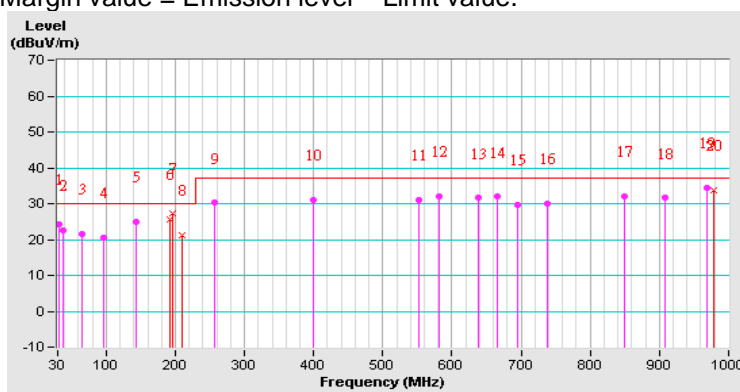

ENVIRONMENTAL CONDITIONS	23 deg. C, 68% RH, 1006 hPa	FREQUENCY RANGE	1-7 GHz
DETECTOR FUNCTION & BANDWIDTH	Peak/Average, 1 MHz	TESTED BY	Kevin Chen

ANTENNA POLARITY & TEST DISTANCE: HORIZONTAL AT 3 M								
No.	Freq. (MHz)	Emission Level (dBuV/m)	Limit (dBuV/m)	Margin (dB)	Antenna Height (m)	Table Angle (Degree)	Raw Value (dBuV)	Correction Factor (dB/m)
1	1067.22	46.78 PK	74.00	-27.22	1.02 H	110	19.58	27.20
2	1067.22	42.68 AV	54.00	-11.32	1.02 H	110	15.48	27.20
3	1331.81	49.92 PK	74.00	-24.08	1.09 H	214	21.90	28.01
4	1331.81	42.93 AV	54.00	-11.07	1.09 H	214	14.92	28.01
5	1659.21	51.48 PK	74.00	-22.52	1.51 H	52	22.44	29.04
6	1659.21	46.78 AV	54.00	-7.22	1.51 H	52	17.74	29.04
7	1825.85	52.21 PK	74.00	-21.79	1.00 H	14	22.61	29.60
8	1825.85	44.53 AV	54.00	-9.47	1.00 H	14	14.93	29.60
9	2331.53	53.31 PK	74.00	-20.69	1.24 H	41	22.02	31.30
10	2331.53	47.27 AV	54.00	-6.73	1.24 H	41	15.98	31.30

- REMARKS:**
1. Emission level(dBuV/m)=Raw Value(dBuV) + Correction Factor(dB/m)
 2. Correction Factor(dB/m) = Antenna Factor (dB/m) + Cable Factor (dB)
 3. The other emission levels were very low against the limit.
 4. Margin value = Emission level – Limit value.

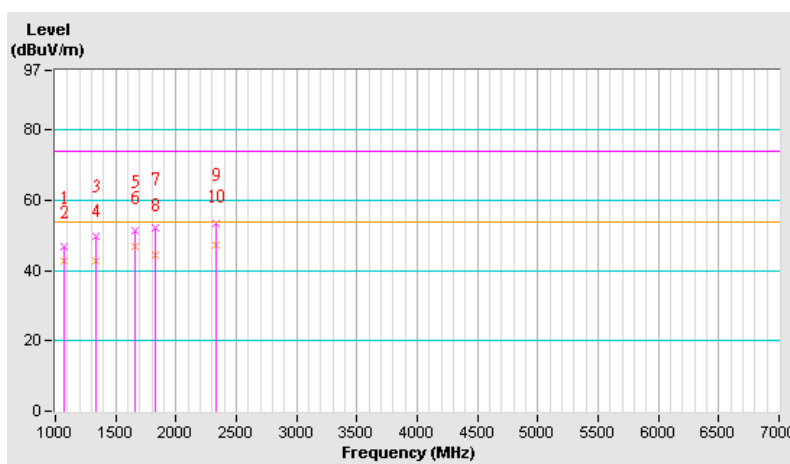

ENVIRONMENTAL CONDITIONS	23 deg. C, 68% RH, 1006 hPa	FREQUENCY RANGE	1-7 GHz
DETECTOR FUNCTION & BANDWIDTH	Peak/Average, 1 MHz	TESTED BY	Kevin Chen

ANTENNA POLARITY & TEST DISTANCE: VERTICAL AT 3 M								
No.	Freq. (MHz)	Emission Level (dBuV/m)	Limit (dBuV/m)	Margin (dB)	Antenna Height (m)	Table Angle (Degree)	Raw Value (dBuV)	Correction Factor (dB/m)
1	1068.00	48.30 PK	74.00	-25.70	1.00 V	360	21.10	27.20
2	1068.00	43.49 AV	54.00	-10.51	1.00 V	360	16.29	27.20
3	1331.51	51.36 PK	74.00	-22.64	1.10 V	214	23.34	28.01
4	1331.51	46.32 AV	54.00	-7.68	1.10 V	214	18.30	28.01
5	1657.68	57.23 PK	74.00	-16.77	1.00 V	16	28.19	29.04
6	1657.68	36.54 AV	54.00	-17.46	1.00 V	16	7.50	29.04
7	1825.08	54.11 PK	74.00	-19.89	1.00 V	23	24.51	29.60
8	1825.08	35.04 AV	54.00	-18.96	1.00 V	23	5.44	29.60
9	1983.39	51.67 PK	74.00	-22.33	1.43 V	15	21.62	30.05
10	1983.39	33.78 AV	54.00	-20.22	1.43 V	15	3.73	30.05

- REMARKS:**
1. Emission level(dBuV/m)=Raw Value(dBuV) + Correction Factor(dB/m)
 2. Correction Factor(dB/m) = Antenna Factor (dB/m) + Cable Factor (dB)
 3. The other emission levels were very low against the limit.
 4. Margin value = Emission level – Limit value.

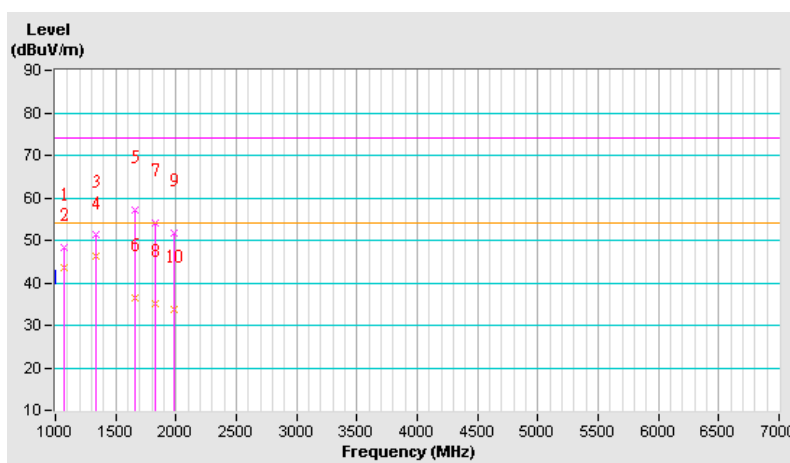

5 PHOTOGRAPHS OF THE TEST CONFIGURATION

Conducted Emission Test

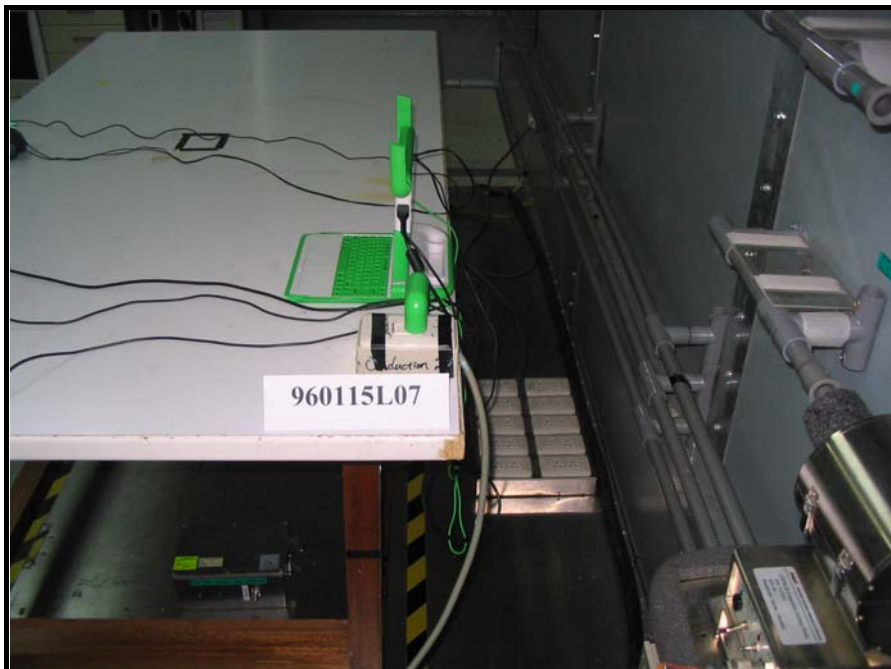

Radiated Emission Test

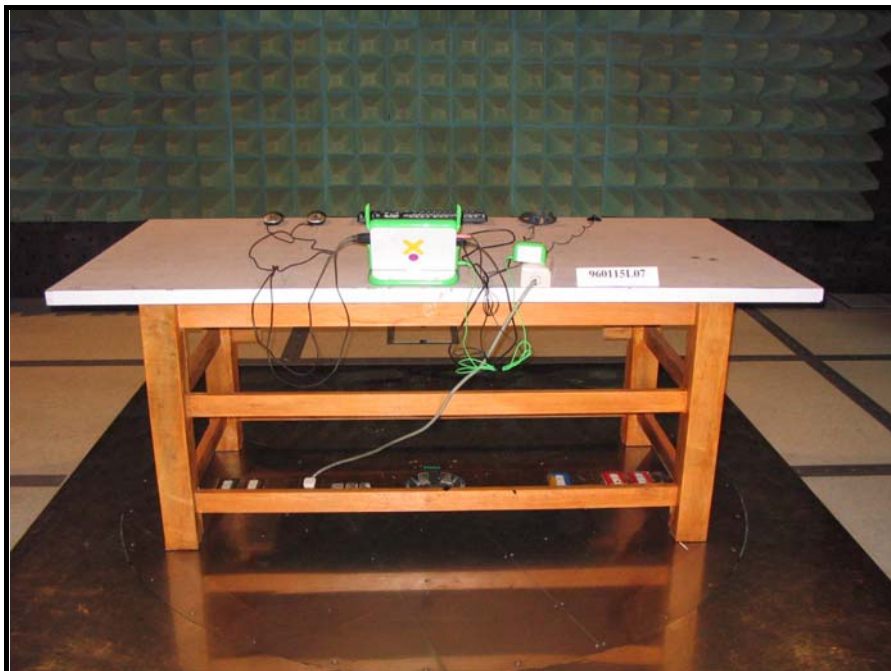
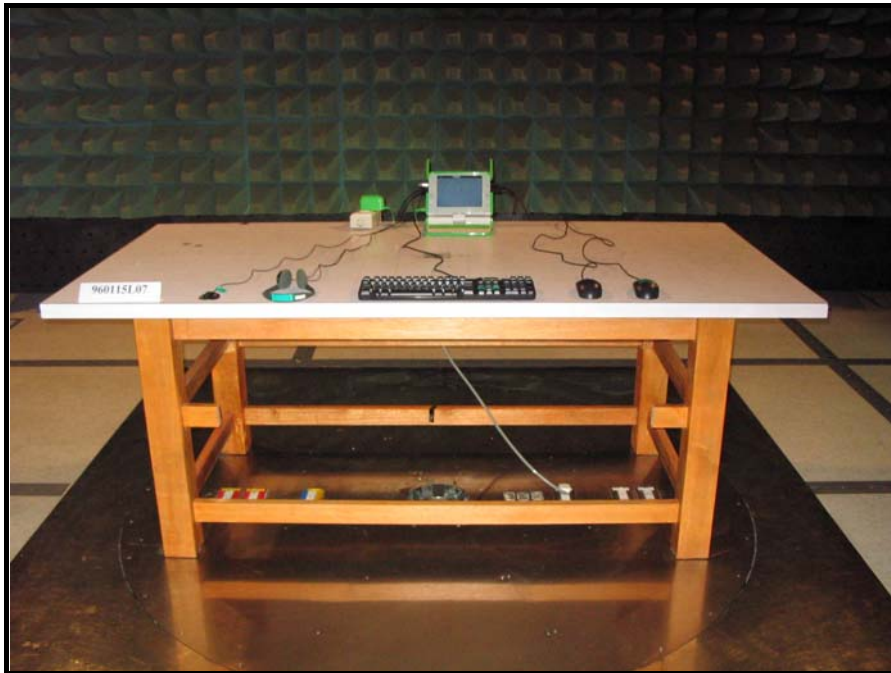



6 INFORMATION ON THE TESTING LABORATORIES

We, ADT Corp., were founded in 1988 to provide our best service in EMC, Radio, Telecom and Safety consultation. Our laboratories are accredited and approved by the following approval agencies according to ISO/IEC 17025:

USA	FCC, UL, A2LA
Germany	TUV Rheinland
Japan	VCCI
Norway	NEMKO
Canada	INDUSTRY CANADA, CSA
R.O.C.	TAF, BSMI, NCC
Netherlands	Telefication
Singapore	GOST-ASIA(MOU)
Russia	CERTIS(MOU)

Copies of accreditation certificates of our laboratories obtained from approval agencies can be downloaded from our web site: www.adt.com.tw/index.5/phtml. If you have any comments, please feel free to contact us at the following:

Linko EMC/RF Lab

Tel: 886-2-26052180

Fax: 886-2-26051924

Hsin Chu EMC/RF Lab

Tel: 886-3-5935343

Fax: 886-3-5935342

Hwa Ya EMC/RF/Safety/Telecom Lab

Tel: 886-3-3183232

Fax: 886-3-3185050

Web Site: www.adt.com.tw

The address and road map of all our labs can be found in our web site also.



7 APPENDIX A –MODIFICATION RECORDERS FOR ENGINEERING CHANGES TO THE EUT BY THE LAB

No any modifications are made to the EUT by the lab during the test.