



CE EMC TEST REPORT

For

Laptop Computer

Brand Name: OLPC
Model NO.: XO-1.75, XO-1.75HS
Report NO.: 20111123-1
Issued Date: Nov. 23, 2011
Issued By: Compliance Laboratory of Tech-Front (Shanghai) Computer Co., Ltd
Lab Address: No. 68, Sanzhuang Road, Songjiang Export Processing Zone, Shanghai, P. R. China
Tel: +86-21-3781-8168
Fax: +86-21-6774-7135

The test result relate only to the samples tested. The test report shall not be reproduced except in full without the written approval of our laboratory. This report must not be used to claim product endorsement by CNAS or any agency of the Government. The test results shown in the test report are traceable to the national/international standard through the calibration of the equipment and evaluated measurement uncertainty herein.



Test Report Certification

Applicant: Quanta Computer Inc
Manufacturer: Quanta Computer Inc
Product: Laptop Computer
Brand Name: OLPC
Model Number: XO-1.75, XO-1.75HS
Tested Voltage: 230V_{AC}, 50Hz
Tested Date: Nov. 15-Nov. 19, 2011

Applicable Standards:

Emission: EN 55022: 2006+A1: 2007, Class B
 EN 61000-3-2: 2006+A1: 2009+A2: 2009
 EN 61000-3-3: 2008

Immunity: EN 55024:1998+A1:2001+A2:2003
 EN 61000-4-2:1995+A1:1998+A2:2001
 EN 61000-4-3:2006
 EN 61000-4-4:2004
 EN 61000-4-5:2006
 EN 61000-4-6:2007
 EN 61000-4-8:1993+A1:2001
 EN 61000-4-11:2004

Test Result	No non-compliance noted
--------------------	-------------------------

The above equipment has been tested by Compliance Laboratory of Tech-Front (Shanghai) Computer Co., Ltd., and found compliance with the requirements set forth in the Electromagnetic Compatibility Directive 2004/108/EC and technical standards mentioned above. The result of testing in this report apply only to the product/system, which was tested. Other similar equipment will not necessarily produce the same results due to production tolerance and measurement uncertainties.

Approved By

Reviewed By

Herculius Hsu/ EMC manager:

Bill Bo/ Senior engineer



Section 1: General Information..... 6

 1.1 Test result summary6

 1.2 Introduction7

 1.3 Test Procedure8

Section 2: Test Facility and Procedure.....9

 2.1 Test Facility used for Emission Testing 9

 2.1.1 Measurement Uncertainty 9

 2.1.2 Lab Accreditation10

 2.1.3 Software to exercise EUT10

 2.1.4 Special Accessories10

 2.1.5 Equipment Modifications and Deviations10

 2.1.6 Test Configuration11

 - Arrangement block diagram 11

 - Associated equipment 11

 - Pre-test configuration13

 - Worst case for final testing 13

 2.1.7 Cable Description and Information13

 2.2 Measurement Equipment 14

 2.2.1 Conducted Emissions14

 2.2.2 Radiated Emissions14

 2.2.3 Power Harmonic / Flickers15

 2.2.4 Electrostatic Discharge (ESD) Immunity15

 2.2.5 Radiated Electromagnetic Field Immunity15

 2.2.6 Fast Transient / Burst Immunity16

 2.2.7 Surge Immunity16

 2.2.8 Conducted Disturbance / Induced Radio-Frequency Field Immunity ...16

 2.2.9 Power Frequency Magnetic Field Immunity17

 2.2.10 Voltage Dips / Short Interruptions and Interruptions17



- Section 3: Electromagnetic Emissions Test**..... 18
 - 3.1 Emission 18
 - 3.1.1 Line Conducted Emissions Test 18
 - Measurement Procedures Utilized for Conducted Emissions 18
 - Limits 19
 - Test setup..... 20
 - Conducted Emissions Test Data 21
 - 3.1.2 Radiated Emissions Test 23
 - Measurement Procedures Utilized for Radiated Emissions 23
 - Limits 24
 - Test setup..... 24
 - Radiated Emissions Test Data 26
 - 3.1.3 Power Harmonics Measurement 30
 - Measurement Procedures Utilized for Harmonics..... 30
 - Test setup..... 31
 - Test Condition..... 31
 - Test results..... 31
 - 3.1.4 Power Voltage Fluctuation / Flicker Measurement32
 - Measurement Procedures Utilized for Flicker..... 32
 - Test setup..... 32
 - Test Condition..... 33
 - Test results..... 33
 - 3.2 Electromagnetic Immunity Report34
 - 3.2.1 Electrostatic Discharge (ESD) Immunity Test35
 - Measurement Procedures Utilized for ESD..... 35
 - Test setup..... 36
 - Test Condition..... 37
 - Test results..... 38
 - 3.2.2 Radiated Electromagnetic Field Immunity Test39
 - Measurement Procedures Utilized for RS..... 39
 - Test setup..... 39
 - Test Condition..... 40
 - Test results..... 40
 - 3.2.3 Fast Transient/Burst Immunity Test.....41
 - Measurement Procedures Utilized for EFT..... 41
 - Test setup..... 41
 - Test Condition..... 42
 - Test results..... 42



- 3.2.4 Surge Immunity Test 43
 - Measurement Procedures Utilized for Surge..... 43
 - Test setup..... 43
 - Test Condition..... 44
 - Test results..... 44
- 3.2.5 Conducted Disturbance / Induced Radio-Frequency Field Immunity Test
 - Measurement Procedures Utilized for CS..... 45
 - Test setup..... 45
 - Test Condition..... 46
 - Test results..... 46
- 3.2.6 Power Frequency Magnetic Field Immunity Test 47
 - Measurement Procedures Utilized for PFMF..... 47
 - Test setup..... 47
 - Test Condition..... 48
 - Test results..... 48
- 3.2.7 Voltage Dips / Short Interruptions and Interruptions Test 49
 - Measurement Procedures Utilized for Dips..... 49
 - Test setup..... 49
 - Test Condition..... 50
 - Test results..... 50
- Section 4: Test Arrangement Photos.....51**
 - 4.1 Conducted Emissions51
 - 4.2 Radiated Emissions52
 - 4.3 Power Harmonics and Flick Measurement 54
 - 4.4 Electrostatic Discharge (ESD)..... 55
 - 4.5 Radiated Electromagnetic Field Immunity..... 58
 - 4.6 Fast Transient / Burst Immunity.....58
 - 4.7 Surge Immunity..... 59
 - 4.8 Conducted Disturbance, Induced Radio-Frequency Field Immunity.....59
 - 4.9 Power Frequency Magnetic Field Immunity Test 60
 - 4.10 Voltage Dips / Short Interruptions and Interruptions..... 60



Section 1: General Information

1.1 Test Result summary

Emission			
Standard	Item	Result	Remarks
EN 55022: 2006+A1: 2007	Conducted (Main Port)	PASS	Meet Class B limit
	Conducted (Telecom port)	PASS	Meet Class B limit
	Radiated	PASS	Meet Class B limit
EN 61000-3-2: 2006	Harmonic current emissions	PASS	NA
EN 61000-3-3 (1995) + A1 (2001) + A2 (2005)	Voltage fluctuations & flicker	PASS	Meets the requirements

Immunity 【EN 55024:1998 + A1: 2001 + A2: 2003】			
Standard	Item	Result	Remarks
EN 61000-4-2: 2009	ESD	PASS	Meets the requirements of Performance Criterion B
EN 61000-4-3: 2006	RS	PASS	Meets the requirements of Performance Criterion A
EN 61000-4-4: 2004	EFT	PASS	Meets the requirements of Performance Criterion B
EN 61000-4-5: 2006	Surge	PASS	Meets the requirements of Performance Criterion B
EN 61000-4-6: 2007	CS	PASS	Meets the requirements of Performance Criterion A
EN 61000-4-8:2001	PFMF	PASS	Meets the requirements of Performance Criterion A
EN 61000-4-11: 2004	Voltage dips & voltage variations	PASS	Meets the requirements of Voltage Dips: 1) >95% reduction Performance Criterion B 2) 30% reduction Performance Criterion C Voltage Interruptions: 1) >95% reduction Performance Criterion C.

- Note:** 1) The test result judgment is decided by the limit of test standard
 2) The information of measurement uncertainty is available upon the customer's request.



1.2 Introduction

Product	Laptop Computer		
Trade Name	OLPC		
Model Name	XO-1.75, XO-1.75HS		
Housing Type	Plastic		
AC Power Adapter	Bestec	Model	NA0241WAA
		Model	BT-AG250SDF
	Darfon	Model	BU24-1203
		Model	BB0J-C
AC Power Adapter Rating	I/P: 100-240Vac O/P: 13.5Vdc, 1.85A/12Vdc, 2A		
AC Power Cord Type	Non-shielded AC 2pin (0.9m)		
DC Power Cable Type	Non-shielded DC (1.5m) /Non-shielded DC (1.8m)		
CPU	Marvell	Model	ARMADA 610
Memory Capacity	512MHz/1GB		
7.5"LCD Panel	CHIMEI	Model	LS075AT011
eMMC	4GB / 8GB		
Camera	SUYIN	Model	CM0316-OLPC01
WLAN	QMI	Model	EM113-MV
	Liteon	Model	WN6301MH
Battery	BYD	Model	CL1



I/O Port:

I/O Port Types	Quantity
Audio in port	1
Audio out port	1
USB port	3
SD Card port	1



1.3 Test Procedure

The EUT was tested using special test software called H patterns, which exercises all external I/O ports as well as the internal storage media by writing and reading (if applicable) a continuous stream of “H” characters in font 9. A pattern of continuous stream-scrolling black “H” on a white background was written to display. Played through the internal audio while the EMC testing was being done. The measurements were made while the system was exercised in this manner.



Section 2: Test Facility and Procedure

2.1 Test Facility Used for Emission Testing

Conducted Emissions Facilities: Conducted Emissions were performed at Compliance Laboratory of Tech - Front (Shanghai) Computer Co, Ltd of No.68 Sanzhuang Road, Songjiang Export Processing Zone, Shanghai, P. R. China
FCC Registration No. 602285
VCCI Registration No. C-2529/ T-1836

Radiated Emissions Facilities: Radiated Emissions measurements were performed at Compliance Laboratory of Tech-Front (Shanghai) Computer Co., Ltd. of No.68 Sanzhuang Road, Songjiang Export Processing Zone, Shanghai, P. R. China

FCC Registration No. 602285

VCCI Registration No. R-2319 (10m Chamber)/ G-191 (10m Chamber) / R-3341 (3m-2Chamber) / G-209 (3m-2 Chamber) /R-2320 (3m Chamber site 1)

Note: "R-"to represent bellows 1GHz, "G-"to represent above 1GHz.

2.1.1 Measurement Uncertainty

The measurement uncertainty has been determined to be the following:

AC Conducted Emissions = 2.4 dB

Telecom Conducted Emissions = 2.8 dB

Radiated Emissions (30MHz~1000MHz) = 3.9 dB





Radiated Emissions (1000MHz~18000MHz) = 4.8 dB

The equipment conforms to the requirement of CISPR 16-1, CISPR 16-4-2, ANSI C63.2 and other required standards.

Calibration of all test and measurement, including any accessories that may effect such calibration, is checked frequently to ensure the accuracy. Adjustments are made and correction factors are applied in accordance with the instructions contained in the respective manual.



2.1.2 Lab Accreditations

Coverage	Agency	Scope of Accreditation	Logo
USA	FCC	3/10 meter chamber and conducted test chamber to perform FCC Part 15/18 measurements	 602285
Japan	VCCI	3/10 meter chamber and conducted test chamber to perform radiated / conducted measurements	 R-2320 / R-2319/ G-191 C-2529/ T-1836
ISO/IEC 17025	CNAS	FCC 47CFR Part 15; CISPR22; AS/NZS CISPR 22; V-3/2008.04; GB9254; GB17625.1; EN55022; EN61000-3-2; EN 61000-3-3; CISPR24; EN55024; IEC/EN61000-4-2; IEC/EN61000-4-3; IEC/EN61000-4-4; IEC/EN61000-4-5; IEC/EN61000-4-6; IEC/EN61000-4-8; IEC/EN61000-4-11	  TESTING CNAS L2894

2.1.3 Software to Exercise EUT

The EUT was tested using special test software called H patterns, which exercises all external I/O ports as well as the internal storage media by writing and reading (if applicable) a continuous stream of “H” characters in font 9. A pattern of continuous stream-scrolling black “H” on a white background was written to display. Played through the internal audio while the EMC testing was being done. The measurements were made while the system was exercised in this manner.

2.1.4 Special Accessories

There were no special accessories used during these tests.

2.1.5 Equipment Modifications and Deviations

There is no EUT modification or test standard deviation.



2.1.6 Test Configuration

The EUT was configured as a worst case system configuration as a result from pre-testing as described below:

Arrangement Block Diagram

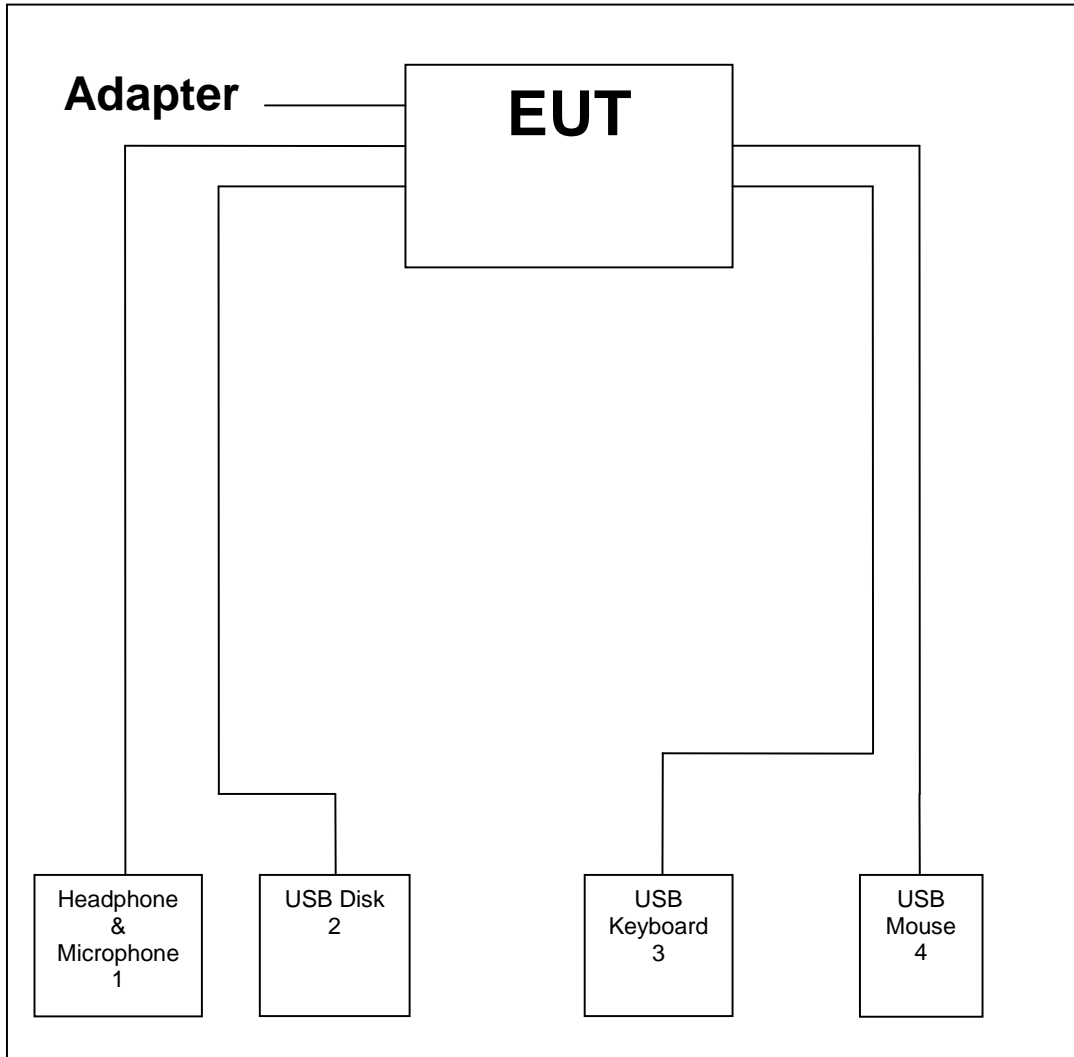

Associated Equipments

No.	Interference	Equipment	Brand	Model
1	Audio in & out port	Mic & Headphone	Philips	SHM3300
2	USB port	Ipod	Apple	A1285
3	USB port	Keyboard	Logitech	Y-BP62a
4	USB port	Mouse	Logitech	M-BP82



Pre-test configuration

Prior to taking the formal emissions data collected in this report many hours of pre-testing have been performed. The selection of the worst case system documented in this report was based upon this pre-testing.

Mode	CPU	LCD Panel	Memory	eMMC	WLAN	Camera	Battery	Adapter
1	Marvell ARMADA 610	CHIMEI LS075AT011	512M	4GB	QMI EM113-MV	AZUREWAVE AM-1H018	BYD CL1	Bestec NA0241WAA
2	Marvell ARMADA 610	CHIMEI LS075AT011	1GB	8GB	Liteon WN6301MH	AZUREWAVE AM-1H018	BYD CL1	Bastec BT-AG250SDF
3	Marvell ARMADA 610	CHIMEI LS075AT011	512M	4GB	QMI EM113-MV	AZUREWAVE AM-1H018	BYD CL1	Darfon BU24-1203
4	Marvell ARMADA 610	CHIMEI LS075AT011	1GB	8GB	Liteon WN6301MH	AZUREWAVE AM-1H018	BYD CL1	Darfon BB0J-C
5	Marvell ARMADA 610	CHIMEI LS075AT011	512M	4GB	QMI EM113-MV	AZUREWAVE AM-1H018	BYD CL1	Bastec BT-AG250SDF
6	Marvell ARMADA 610	CHIMEI LS075AT011	1GB	8GB	Liteon WN6301MH	AZUREWAVE AM-1H018	BYD CL1	Darfon BU24-1203
7	Marvell ARMADA 610	CHIMEI LS075AT011	1GB	8GB	QMI EM113-MV	AZUREWAVE AM-1H018	BYD CL1	Darfon BB0J-C
8	Marvell ARMADA 610	CHIMEI LS075AT011	512M	4GB	Liteon WN6301MH	AZUREWAVE AM-1H018	BYD CL1	Bastec NA0241WAA
9	Marvell ARMADA 610	CHIMEI LS075AT011	1GB	8GB	QMI EM113-MV	AZUREWAVE AM-1H018	BYD CL1	Bastec NA0241WAA
10	Marvell ARMADA 610	CHIMEI LS075AT011	512M	4GB	Liteon WN6301MH	AZUREWAVE AM-1H018	BYD CL1	Darfon BB0J-C



Worst Case for Final Testing (Mode 4 chosen)

Component	Vendor	Part Number
CPU	Marvell	ARMADA 610
LCD Panel	CHIMEI	LS075AT011
Memory	Hynix	1GB
eMMC	Toshiba	8GB
WLAN	Liteon	WN6301MH
Camera	AZUREWAVE	AM-1H018
Battery	BYD	CL1
Power Adapter	Darfon	BB0J-C

2.1.7 Cable Description and Information

Cable Type	Shielded	Ferrite	Length
USB Keyboard	No	No	1.5m
USB Mouse	No	No	1.8m
USB 2.0 Ipad	Yes	No	1.0m
Audio In	No	No	1.8m
Audio Out	No	No	1.8m



2.2 Measurement Equipment

N/A is an abbreviation for Not Applicable. All equipments are traceable to CNAS calibration standards.

2.2.1 Conducted Emissions

Description	Manufacturer	Model No.	Serial No.	Calibrated Until
Test Receiver	Rohde & Schwarz	ESCI	100167	5/24/2012
LISN	Schwarz beck	NSLK8127	8127433	5/24/2012
LISN	Schwarz beck	NSLK8128	8128229	5/24/2012
TLISN	TeseQ	CDN ST08A	30189	5/24/2012
TLISN	TeseQ	ISN ST800	29453	5/24/2012
TLISN	FCC	FCC-TLISN-T4-02	20581	5/24/2012
TLISN	FCC	FCC-TLISN-T8-02	20445	5/24/2012
Probe	FCC	F-33-4	57	5/24/2012
Probe	FCC	F35	507	5/30/2012
Software	ADT	ADT_Cond_V7.3.4	N/A	N/A

2.2.2 Radiated Emissions

Description	Manufacturer	Model No.	Serial No.	Calibrated Until
Test Receiver	Rohde & Schwarz	ESCI	100166	5/24/2012
Test Receiver	Rohde & Schwarz	ESIB26	100307	5/24/2012
Spectrum Analyzer	Agilent	E7405A	MY42000093	5/24/2012
Bilog Antenna	Schwarz beck	VULB9168	9168-198	5/21/2012
Bilog Antenna	Schwarz beck	VULB9168	9168-195	5/21/2012
Horn Antenna	Schwarz beck	BBHA 9120D	409	5/21/2012
Preamplifier	Agilent	8447D	2944A10848	5/24/2012
Preamplifier	Agilent	8447D	2944A10847	5/24/2012
Preamplifier	Agilent	8449B	3008A02145	5/24/2012
Preamplifier	Agilent	8449B	3008A02146	5/24/2012
Software	ADT	ADT_Radiated_V7	N/A	N/A
Antenna Mast	Inn-co	MA4000	MA4000/101/977 0405/L	N/A
Antenna Mast	Inn-co	MA4000	MA4000/104/977 0405/L	N/A
Turn Table	Inn-co	DT3000-1T-C	DT3000-1T-C/22	N/A
Controller	Inn-co	CO2000	CO2000/218/977 0405/L	N/A

**2.2.3 Power Harmonics and Voltage Fluctuation/Flicker**

Description	Manufacturer	Model No.	Serial No.	Calibrated Until
AC Power Source	EMTest	ACS 500	V0523100459	5/24/2012
Harmonics & Flicker Analyzer	EMTest	DPA 500	V0523100458	5/24/2012
Software	EMTest	EMTest software	N/A	N/A

2.2.4 Electrostatic Discharge (ESD) Immunity

Description	Manufacturer	Model No.	Serial No.	Calibrated Until
ESD Simulator	EMTest	ESD 30C	V0523100460	5/30/2012
ESD Simulator	Noiseken	ESS-2002	ESS0423758	5/30/2012
ESD Simulator	TESEQ	NSG435	6251	5/30/2012
ESD Simulator	TESEQ	NSG435	6253	5/30/2012

2.2.5 Radiated Electromagnetic Field Immunity

Description	Manufacturer	Model No.	Serial No.	Calibrated Until
Amplifier	Amplifier Research	150W1000	312368	5/24/2012
Amplifier	Amplifier Research	60S1G3 (M1)	312416	5/24/2012
Antenna	Amplifier Research	AT5080	312113	N/A
Antenna Tripod	Evergo	TP1000A	N/A	N/A
Field Monitoring	Amplifier Research	IF4000A	310906	N/A
Probe	Amplifier Research	FP6001	307201	5/30/2012
Power Meter	Boonton	4232A	142402	5/24/2012
Power Sensor	Boonton	51011EMC	33838	5/24/2012
Power Sensor	Boonton	51011EMC	33839	5/24/2012
Double-coupling	Amplifier Research	DC6180A	312192	N/A
Double-coupling	Amplifier Research	DC7144A	311989	N/A
Controller	Amplifier Research	SC1000M1	312477	N/A
Signal Generator	Rohde& Schwarz	SML03	102270	5/24/2012
Software	ADT	ADT_RS_V7	N/A	N/A

**2.2.6 Fast Transient/Burst Immunity**

Description	Manufacturer	Model No.	Serial No.	Calibrated Until
EFT Generator	EMTest	EFT500	V0523100450	5/24/2012
Clamp	EMTest	HFK	0605-08	5/30/2012
Software	EMTest	EMTest Software	N/A	N/A

2.2.7 Surge Immunity

Description	Manufacturer	Model No.	Serial No.	Calibrated Until
Telecom surge generator	EMTest	TSS 500 M10	0523100456	5/24/2012
Impulse Generator	EMTest	VCS 500 M10	V0523100451	5/24/2012
CDN	EMTest	CNV504 S4	V054221000813	N/A
CDN	EMTest	CNV504 S1	V0523100455	N/A
Software	EMTest	EMTest Software	N/A	N/A

2.2.8 Conducted Disturbance/Induced Radio-Frequency Field Immunity

Description	Manufacturer	Model No.	Serial No.	Calibrated Until
Continuous Wave Simulator	EMTest	CWS 500C	V053100457	5/24/2012
Attenuator	EMTest	ATT 6/75	1104-13	5/24/2012
CDN	EMTest	CDN-M2/M3	0705-02	5/24/2012
CDN	EMTest	CDN-T2	0705-01	5/24/2012
CDN	EMTest	CDN-T4	0705-01	5/24/2012
EM Clamp	EMTest	EM Clamp	35737	5/24/2012
CA M2/M3/AF3	EMTest	CA M2/M3/AF3	N/A	N/A
coupling clamp	EMTest	HFK (-4)	0605-08	N/A
CDN	EMTest	CDN-M1	0705-01	N/A
CDN	EMTest	CDN-AF4	0705-01	N/A
Software	EMTest	EMTest Software	N/A	N/A



2.2.9 Power Frequency Magnetic Field Immunity

Description	Manufacturer	Model No.	Serial No.	Calibrated Until
Current transformer	EMTest	MC 2630 (-8)	0705-04	N/A
Motorized Variation	EMTest	MV 2616 (-8)	V0523100453	N/A
Power Fail Simulator	EMTest	UCS500M4-PFS	V0523100452	5/24/2012
Coil	EMTest	MS100	0605-1	5/24/2012
Software	EMTest	EMTest Software	N/A	N/A

2.2.10 Voltage Dips and Short Interruptions

Description	Manufacturer	Model No.	Serial No.	Calibrated Until
Power Fail Simulator	EMTest	UCS500M4-PFS	V0523100452	5/24/2012
Software	EMTest	EMTest Software	N/A	N/A



Section3: Electromagnetic Emissions Test

3.1 Emission

3.1.1 Line Conducted Emissions Test

- Measurement Procedures Utilized for Conducted Emissions

The EUT was set up as per the test configuration to simulate typical usage per the user's manual. When the EUT is a tabletop system, a wooden table with a height of 0.8 meters is used and is placed on the ground plane as per EN 55022.

Associated equipment, if needed, was placed as per EN 55022.

All I/O cables were positioned to simulate typical actual usage as per EN 55022.

The test equipment EUT installed received AC power through a Line Impedance Stabilization Network (LISN), which supplied power source and was grounded to the ground plane.

All associated equipment received power from a second LISN.

For conducted emission test on telecommunication ports, a telecommunication port is connected by its signal cable to an impedance stabilization network (ISN). During the testing, the LAN utilization is in excess of 10 % and sustains that level for a minimum of 250 ms. the traffic rate is monitored by the program of Net Speed.

The EUT test program was started. Emissions were measured on each current carrying line of the EUT using an EMI Test Receiver connected to the LISN powering the EUT.

The Receiver scanned from 150 KHz to 30MHz for emissions in each of the test modes.

During the above scans under battery charging mode, the emissions were maximized by cable manipulation.

The EUT configuration and cable configuration of the above highest emission level were recorded for reference of the final test.



- Limits

For AC Power

Frequency (MHz)	Class A (dBuV)		Class B (dBuV)	
	Quasi-peak	Average	Quasi-peak	Average
0.15 - 0.5	79	66	66 - 56	56 - 46
0.50 - 5.0	73	60	56	46
5.0 - 30.0	73	60	60	50

- Note:** 1) The lower limit shall apply at the transition frequencies.
 2) The limit decreases in line with the logarithm of the frequency in the range of 0.15MHz to 0.50MHz.
 3) All emanations from a class A/B digital device or system, including any network of conductors and apparatus connected thereto, shall not exceed the level of field strengths specified above.

For ISN

For Class A Equipment

FREQUENCY (MHz)	Voltage Limit (dBuV)		Current Limit (dBuA)	
	Quasi-peak	Average	Quasi-peak	Average
0.15 ~ 0.5	97 ~ 87	84 ~ 74	53 ~ 43	40 ~ 30
0.5 ~ 30.0	87	74	43	30

- Note:** 1) The limits decrease linearly with the logarithm of the frequency in the range 0.15 MHz to 0.5MHz.
 2) The current and voltage disturbance limits are derived for use with an impedance stabilization network (ISN) which presents a common mode (asymmetric mode) impedance of 150Ω to the telecommunication port under test (conversion factor is $20\log_{10}150=44\text{dB}$).

For Class B Equipment

FREQUENCY (MHz)	Voltage Limit (dBuV)		Current Limit (dBuA)	
	Quasi-peak	Average	Quasi-peak	Average
0.15 - 0.5	84 ~ 74	74 ~ 64	40 ~ 30	30 ~ 20
0.5 – 30.0	74	64	30	20

- Note:** 1) The limits decrease linearly with the logarithm of the frequency in the range 0.15 MHz to 0.5MHz.
 2) The current and voltage disturbance limits are derived for use with an impedance stabilization network (ISN) which presents a common mode (asymmetric mode) impedance of 150Ω to the telecommunication port under test (conversion factor is $20\log_{10}150 = 44\text{dB}$).



- Test Setup

For AC power setup as below

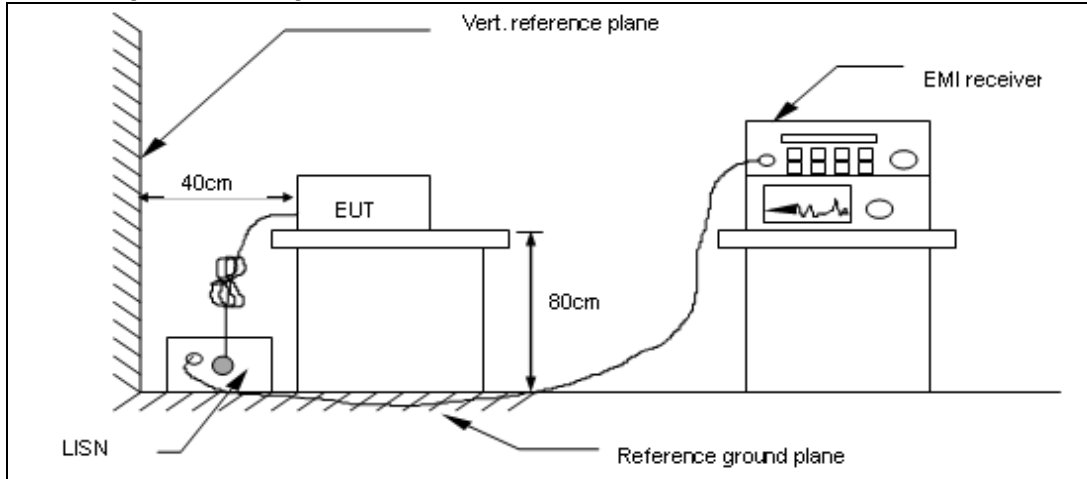

For ISN setup as below

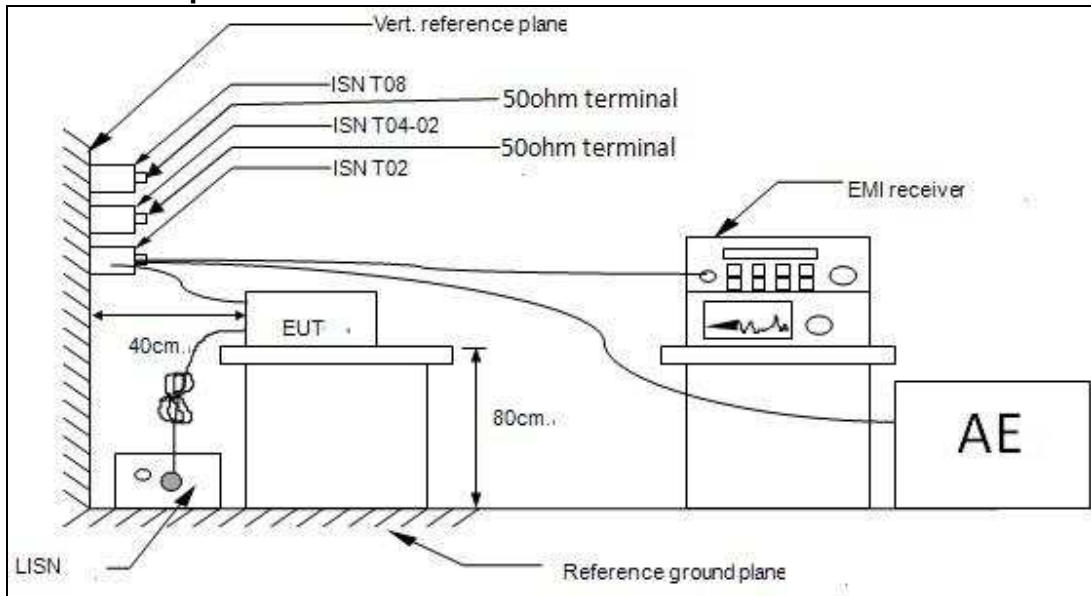

For the actual test configuration, please refer to the related item–Photographs of the Test Configuration.



Conducted Emissions Test Data

Engineer : Andy zhang	Location : Conduction Room
Limit : EN55022 Class B	Probe : Line 1
EUT : Laptop Computer	Date : 2011-11-16
Power : AC 230V/50Hz	Detector : Quasi peak and Average
Temperature. : 28°C Relative Humidity.: 57% Atmospheric Pressure.: 101.5kpa	

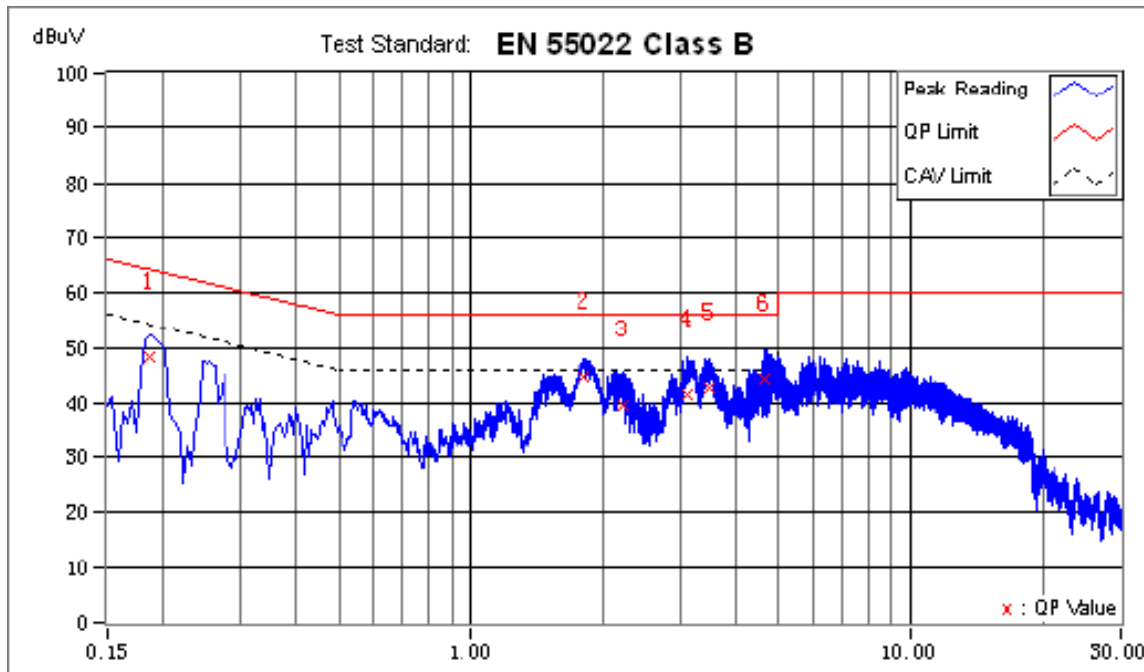

No.	Frequency MHz	Corr. Factor dB	Reading dBuV		Emission dBuV		Limit dBuV		Margins dB		Notes
			QP	CAV	QP	CAV	QP	CAV	QP	CAV	
1	0.18610	11.48	37.36	22.42	48.84	33.90	64.21	54.21	-15.37	-20.31	
2	1.80998	10.66	33.95	23.36	44.61	34.02	56.00	46.00	-11.39	-11.98	
3	2.22995	10.65	29.71	20.76	39.36	31.41	56.00	46.00	-16.64	-14.59	
4	3.10189	10.72	30.86	22.30	41.58	33.02	56.00	46.00	-14.42	-12.98	
5	3.50186	10.74	32.09	22.32	42.83	33.06	56.00	46.00	-13.17	-12.94	
+6	4.64978	10.78	33.43	24.11	44.21	34.89	56.00	46.00	-11.79	-11.11	

Note: 1) Conducted Emissions data was taken at 230Vac, 50Hz. This data was found to be equivalent or lower than the data listed above.
 2) Emission (dBuV) = Reading (dBuV) + Correction factor (dB)
 Margins (dB) = Emission (dBuV) – Limit (dBuV)



Engineer : Andy zhang	Location : Conduction Room
Limit : EN55022 Class B	Probe : Line 2
EUT : Laptop Computer	Date : 2011-11-16
Power : AC 230V/50Hz	Detector : Quasi peak and Average
Temperature. : 28°C Relative Humidity.: 57% Atmospheric Pressure.: 101.5kpa	

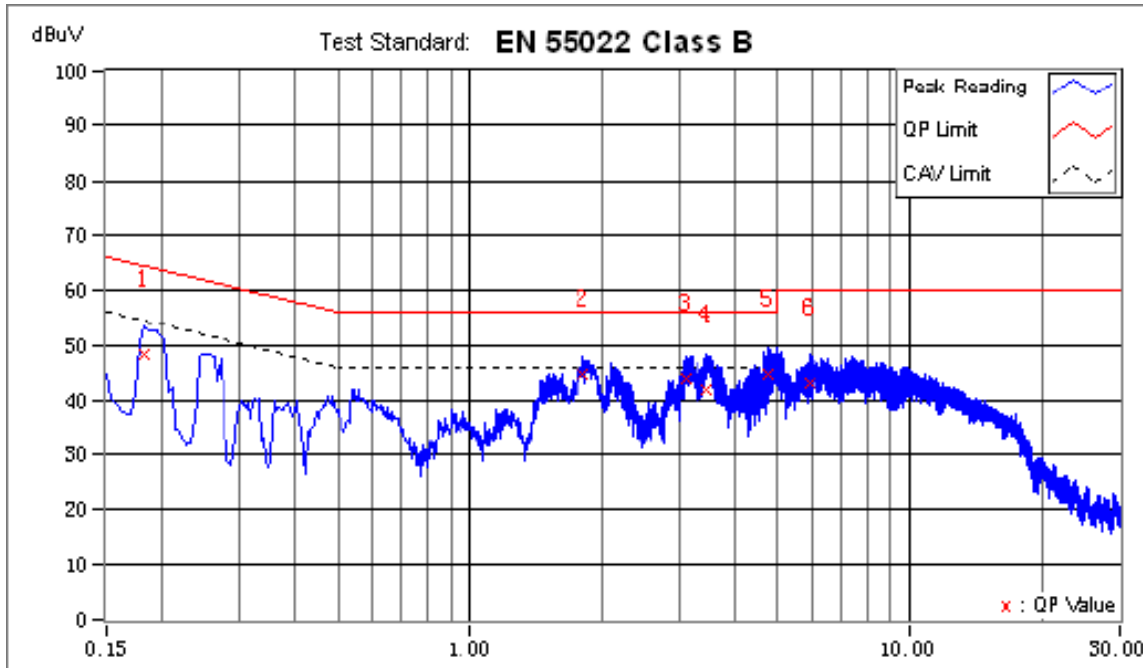

No.	Frequency MHz	Corr. Factor dB	Reading dBuV		Emission dBuV		Limit dBuV		Margins dB		Notes
			QP	CAV	QP	CAV	QP	CAV	QP	CAV	
1	0.18210	11.43	37.49	20.96	48.92	32.39	64.39	54.39	-15.47	-22.00	
2	1.80998	10.63	33.67	22.44	44.30	33.07	56.00	46.00	-11.70	-12.93	
3	3.07769	10.69	32.99	21.99	43.68	32.66	56.00	46.00	-12.32	-13.32	
4	3.47387	10.72	31.18	21.72	41.90	32.44	56.00	46.00	-14.10	-13.56	
+5	4.76578	10.77	33.91	25.21	44.68	35.98	56.00	46.00	-11.32	-10.02	
6	5.91369	10.84	32.12	19.97	42.96	30.81	60.00	50.00	-17.04	-19.19	

Note: 1) Conducted Emissions data was taken at 230Vac, 50Hz. This data was found to be equivalent or lower than the data listed above.
 2) Emission (dBuV) = Reading (dBuV) + Correction factor (dB)
 Margins (dB) = Emission (dBuV) – Limit (dBuV)



3.1.2 Radiated Emissions Test

- Measurement Procedures Utilized for Radiated Emissions

The equipment was set up as per the test configuration to simulate typical usage per the user's manual. When the EUT is a tabletop system, a wooden turntable with a height of 0.8 meters is used which is placed on the ground plane.

Associated equipment, if needed, was placed as per EN 55022.

All I/O cables were positioned to simulate typical usage as per EN 55022.

The EUT received AC power source, from the outlet socket under the turntable. All associated equipment received power from another socket under the turntable.

Mains cables, telephone lines or other connections to auxiliary equipment located outside the test are shall drape to the floor. No extension cords shall be used to mains receptacle.

The antenna was placed at 10 meter away from the EUT as stated in EN 55022. The antenna connected to the Receiver via a cable and at times a pre-amplifier would be used. The receiver scanned from 30MHz to 1000MHz. The EUT test program was started. Emissions were scanned under battery charging mode and measured rotating the EUT to 360 degrees and positioning the antenna 1 to 4 meters above the ground plane, in both vertical and horizontal polarization, to maximize the emission reading level.

The EUT was set 3 meters away from the interference-receiving antenna, which was mounted on the top of a variable-height antenna tower. The height of antenna can be varied from one meter to four meters; the height of adjustment depends on the EUT height and the antenna 3dB beam width both, to detect the maximum value of the field strength. Both horizontal and vertical polarizations of the antenna are set to make the measurement. For each suspected emission, the EUT was arranged to its worst case and then the antenna was tuned to heights and the rotatable table was turned from 0 degrees to 360 degrees to find the maximum reading. The test-receiver system was set to peak and average detect function and specified bandwidth with maximum hold mode when the test frequency is above 1 GHz

The test mode(s) described in Item 2.1.6 were scanned during the preliminary test:

After the preliminary scan, we found the test mode described in Item 2.1.6 producing the highest emission level.

The EUT and cable configuration, antenna position, polarization and turntable position of the above highest emission level were recorded for the final test.



-Limits

For 30MHz~1000MHz

FREQUENCY (MHz)	dBuV/m	
	Class A	Class B
30 ~ 230	40	30
230 ~ 1000	47	37

NOTE: 1) The lower limit shall apply at the transition frequencies.
 2) Emission level (dBuV/m) = 20 log₁₀ Emission level (uV/m).

For 1GHz~6GHz

FREQUENCY (MHz)	dBuV/m	
	PK Limit	AV Limit
1GHz~3GHz	70	50
3GHz~6GHz	74	54

NOTE: 1) The lower limit shall apply at the transition frequencies.
 2) Emission level (dBuV/m) = 20 log Emission level (uV/m).

-Test Setup

For 30MHz~1000MHz test setup as below

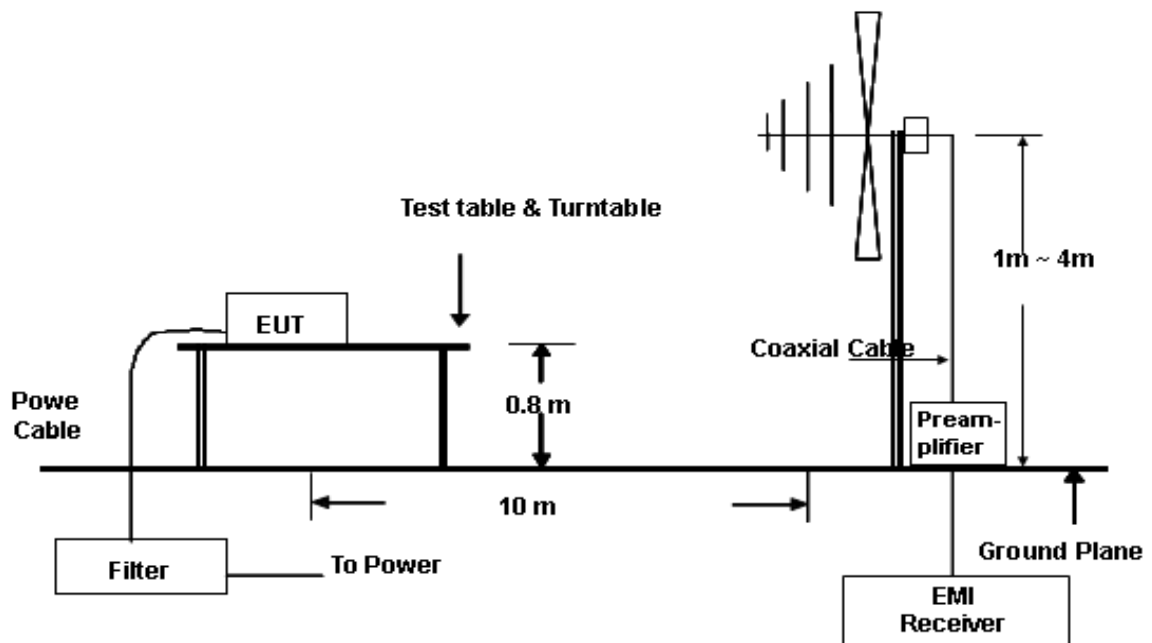



For 1GHz~6GHz test setup as below

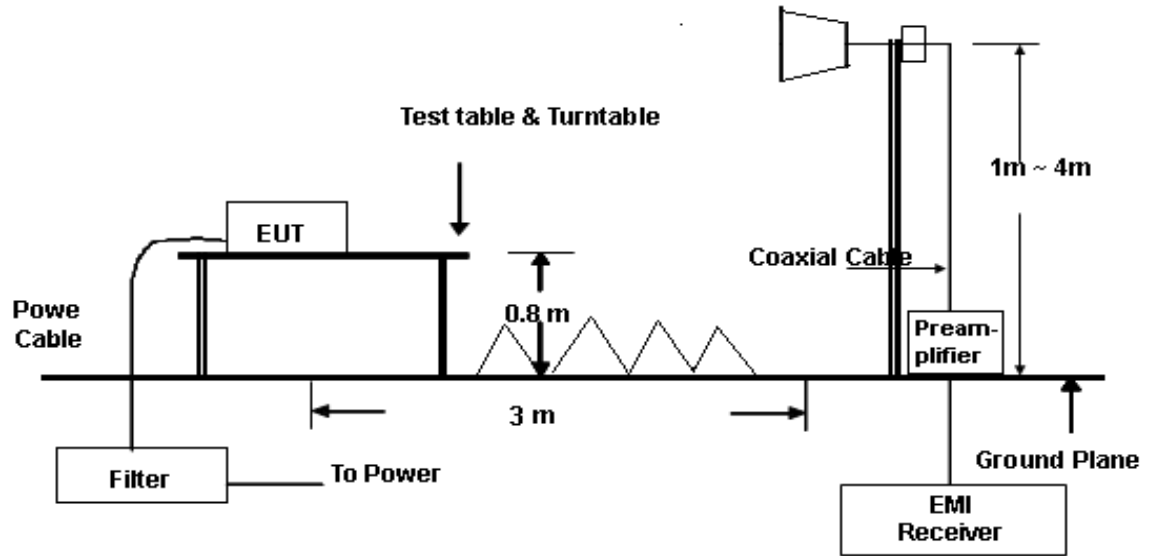

For the actual test configuration, please refer to the related item - Photographs of the Test Configuration.



Radiated Emissions Test Data

Engineer : Andy zhang	Location : 10m Radiation Chamber
Limit : EN55022 Class B	Polarity :Vertical
EUT : Laptop Computer	Date : 2011-11-15
Power : AC 230V/50Hz	Detector : Quasi peak
Temperature. : 20°C Relative Humidity.: 62% Atmospheric Pressure.: 101kpa	

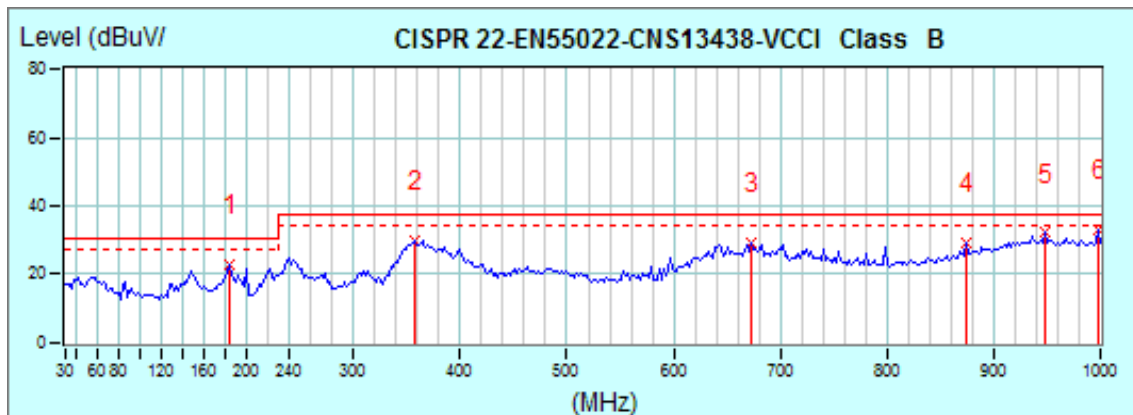

No.	Frequency MHz	Factor dB/m	Reading dBUV	Emission dBUV/m	Limit dBUV/m	Margin dB	Tower / Table cm deg
1	183.53 (QP)	12.98	10.01	22.99	30.00	-7.01	326 211
2	356.56 (QP)	20.79	9.08	29.87	37.00	-7.13	264 342
3	673.44 (QP)	27.07	1.66	28.73	37.00	-8.27	108 253
4	873.68 (QP)	27.20	1.52	28.72	37.00	-8.28	203 357
5	947.56 (QP)	29.95	1.88	31.83	37.00	-5.17	226 350
*	6 998.11 (QP)	28.84	3.66	32.50	37.00	-4.50	268 9

Note: 1).Radiated Emissions data was taken at 230Vac, 50Hz. This data was found to be equivalent or lower than the data listed above.

2).Emission (dBUV) = Reading (dBUV) + Correction factor (dB)

Margins (dB) = Emission (dBUV) – Limit (dBUV)



Engineer : Andy zhang	Location : 10m Radiation Chamber
Limit : EN55022 Class B	Polarity : Horizontal
EUT : Laptop Computer	Date : 2011-11-15
Power : AC 230V/50Hz	Detector : Quasi peak
Temperature. : 20°C Relative Humidity.: 62% Atmospheric Pressure.: 101kpa	

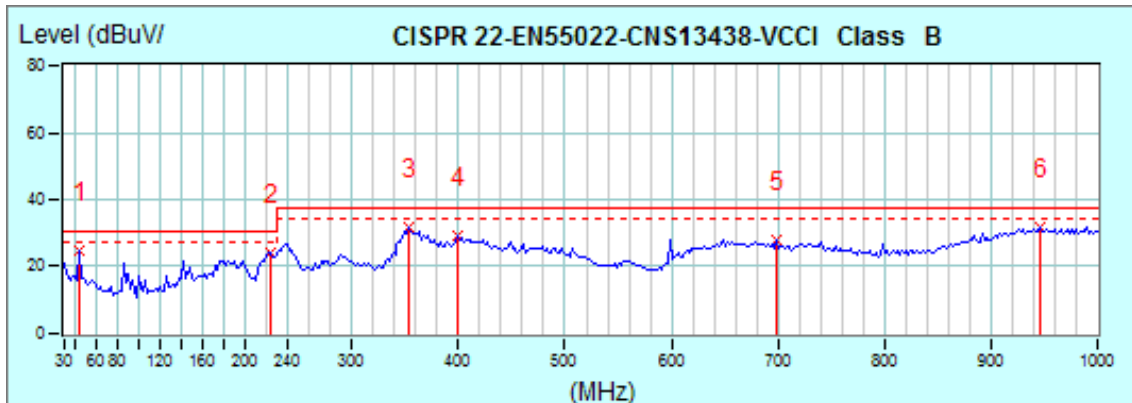

No.	Frequency MHz	Factor dB/m	Reading dBuV	Emission dBuV/m	Limit dBuV/m	Margin dB	Tower / Table cm	dea
* 1	43.53 (QP)	15.74	8.87	24.61	30.00	-5.39	256	344
2	223.97 (QP)	11.92	12.02	23.94	30.00	-6.06	354	123
3	353.96 (QP)	20.24	11.25	31.49	37.00	-5.51	399	196
4	398.59 (QP)	19.85	9.25	29.10	37.00	-7.90	400	279
5	699.32 (QP)	26.33	1.62	27.95	37.00	-9.05	153	15
6	945.72 (QP)	30.07	1.29	31.36	37.00	-5.64	362	263

Note: 1).Radiated Emissions data was taken at 230Vac, 50Hz. This data was found to be equivalent or lower than the data listed above.

2).Emission (dBuV) = Reading (dBuV) + Correction factor (dB)

Margins (dB) = Emission (dBuV) – Limit (dBuV)



For 1GHz~6GHz

Engineer : Andy zhang	Location : 3m-2 Radiation Chamber
Limit : EN55022 Class B	Polarity :Vertical
EUT : Laptop Computer	Date : 2011-11-15
Power : AC 230V/50Hz	Detector: Peak & Average
Temperature. : 25°C Relative Humidity.: 70% Atmospheric Pressure.: 101kpa	

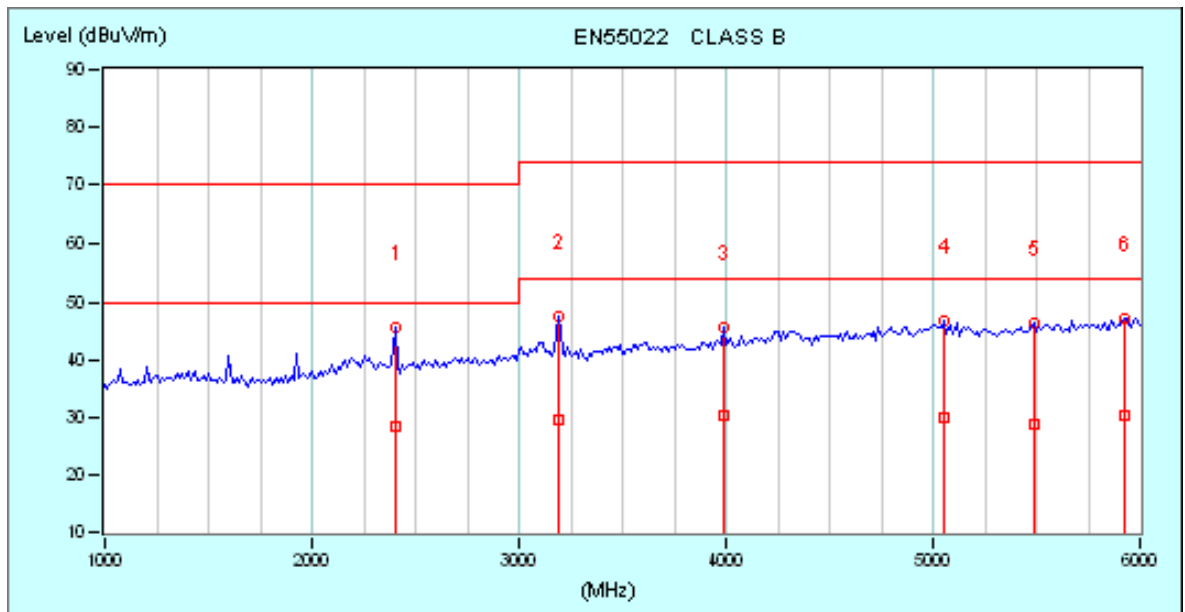

No.	Freq. MHz	C.F. dB/m	Reading		Emission		Limit		Margin		Ant./Table	
			PK	AV	PK	AV	PK	AV	PK	AV	cm	deg
* 1	2400.00	30.98	14.45	-2.72	45.43	28.26	70.00	50.00	-24.57	-21.74	169	246
2	3187.50	32.74	14.63	-3.35	47.37	29.39	74.00	54.00	-26.63	-24.61	322	49
3	3987.50	34.65	11.09	-4.37	45.74	30.28	74.00	54.00	-28.26	-23.72	285	321
4	5050.00	37.62	9.12	-7.85	46.74	29.77	74.00	54.00	-27.26	-24.23	166	274
5	5487.50	37.39	9.09	-8.75	46.48	28.64	74.00	54.00	-27.52	-25.36	339	220
6	5925.00	38.65	8.34	-8.51	46.99	30.14	74.00	54.00	-27.01	-23.86	178	99

Note: 1).Radiated Emissions data was taken at 230Vac, 50Hz. This data was found to be equivalent or lower than the data listed above.

2).Emission (dBUV) = Reading (dBUV) + Correction factor (dB)

Margins (dB) = Emission (dBUV) – Limit (dBUV)



Engineer : Andy zhang	Location : 3m-2 Radiation Chamber
Limit : EN55022 Class B	Polarity : Horizontal
EUT : Laptop Computer	Date : 2011-11-15
Power : AC 230V/50Hz	Detector : Peak & Average
Temperature. : 25°C Relative Humidity.: 70% Atmospheric Pressure.: 101kpa	

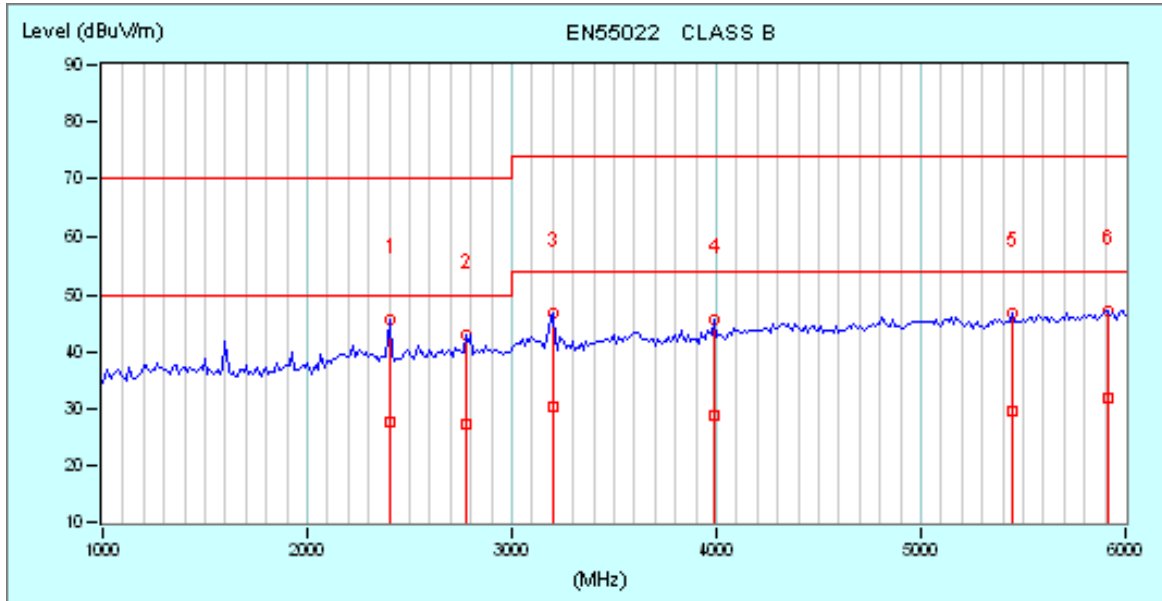

No.	Freq. MHz	C.F. dB/m	Reading		Emission		Limit		Margin		Ant./Table	
			PK	AV	PK	AV	PK	AV	PK	AV	cm	deg
1	2400.00	30.98	14.52	-3.41	45.50	27.57	70.00	50.00	-24.50	-22.43	254	330
2	2775.00	32.04	10.77	-4.78	42.81	27.26	70.00	50.00	-27.19	-22.74	196	287
3	3200.00	32.71	13.87	-2.30	46.58	30.41	74.00	54.00	-27.42	-23.59	378	199
4	3987.50	34.65	10.93	-5.96	45.58	28.69	74.00	54.00	-28.42	-25.31	115	23
5	5450.00	37.25	9.31	-7.89	46.56	29.36	74.00	54.00	-27.44	-24.64	268	354
* 6	5912.50	38.63	8.62	-6.94	47.25	31.69	74.00	54.00	-26.75	-22.31	366	147

Note: 1).Radiated Emissions data was taken at 230Vac, 50Hz. This data was found to be equivalent or lower than the data listed above.

2).Emission (dBuV) = Reading (dBuV) + Correction factor (dB)

Margins (dB) = Emission (dBuV) – Limit (dBuV)



3.1.3 Power Harmonics Measurement

The product was tested and met the requirements specified in EN61000-3-2.

- Measurement Procedures Utilized for Harmonics

- 1) The EUT was placed on the top of a wooden table 0.8 meters above the ground and operated to produce the maximum harmonic components under normal operating conditions for each successive harmonic component in turn.
- 2) The classification of EUT is according to section 5 of EN 61000-3-2.
- 3) The EUT is classified as follows:
 - Class A: Balanced three-phase equipment, Household appliances excluding equipment as Class D, Tools excluding portable tools, Dimmers for incandescent lamps, audio equipment, equipment not specified in one of the three other classes.
 - Class B: Portable tools; Arc welding equipment which is not professional equipment.
 - Class C: Lighting equipment.
 - Class D: Equipment having a specified power less than or equal to 600 W of the following types: Personal computers and personal computer monitors and television receivers.
- 4) The correspondent test program of test instrument to measure the current harmonics emanated from EUT is chosen. The measure time shall be not less than the time necessary for the EUT to be exercised.



- Test Setup

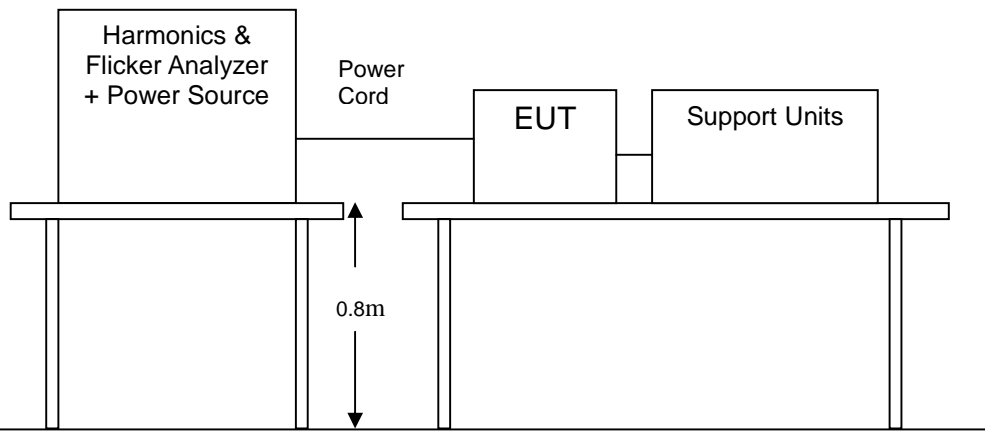

For the actual test configuration, please refer to the related item - Photographs of the Test Configuration.

-Test Condition

Equipment Tested	Laptop Computer
Test Software	H pattern
Test Standard	EN 61000-3-2
Test Operator	Andy Zhang
Date of Test	11/18/2011
Relative Humidity	58%
Temperature	22°C
Atmospheric Pressure	100.5kPa

-Test Results

Fundamental voltage	230V
Power Frequency	50Hz
Observation Date	150sec
Power Consumption	23.66W
Power factor	64.9%
Test Result (Pass/Fail)	Pass

Note: According to EN61000-3-2 paragraph 7 the note1 and 2 are valid for all applications having an active input >75W, others the result should be pass.



3.1.4 Power Voltage Fluctuation/ Flicker Measurement

The product was tested and met the requirements specified in EN 61000-3-3

- Measurement Procedures Utilized for Flicker

- 1) The EUT was placed on the top of a wooden table 0.8 meters above the ground and operated to produce the most unfavorable sequence of voltage changes under normal operating conditions.
- 2) During the flick measurement, the measure time shall include that part of whole operation cycle in which the EUT produce the most unfavorable sequence of voltage changes. The observation period for short-term flicker indicator is 10 minutes.

- Test Setup

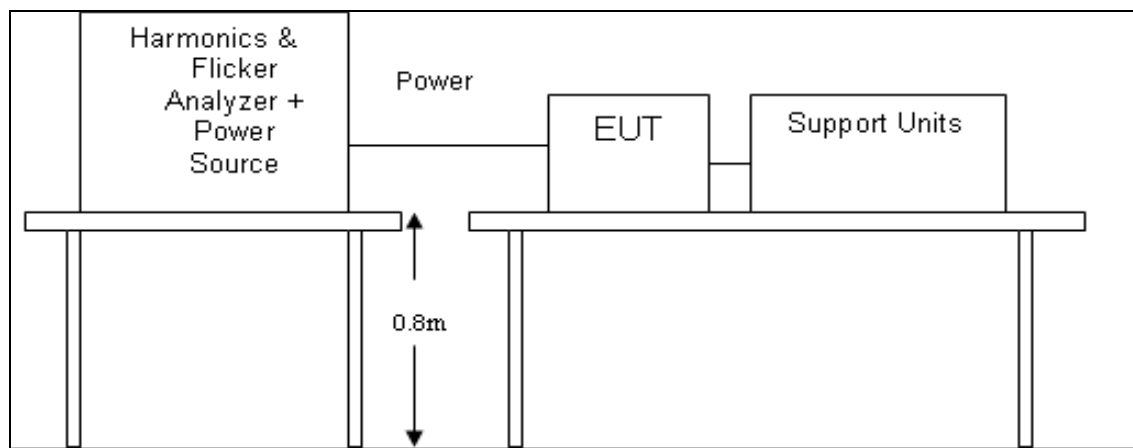

For the actual test configuration, please refer to the related item – Photographs of the Test Configuration.

**-Test Condition**

Equipment Tested	Laptop Computer
Test Software	H pattern
Test Standard	EN 61000-3-3
Test Operator	Andy Zhang
Date of Test	11/18/2011
Relative Humidity	55%
Temperature	25°C
Atmospheric Pressure	100.5kPa

-Test Results

	EUT Values	Limit	Result	Remark
P_{st}	0.028	1.00	Pass	P_{st} means short-term flicker indicator
P_{lt}	0.028	0.65	Pass	P_{lt} means long-term flicker indicator
d_c [%]	0.004	3.30	Pass	d_c means relative steady-state voltage change
d_{max} [%]	0.134	4.00	Pass	d_{max} means maximum relative voltage change
d_t [s]	0.000	0.50	Pass	T_{dt} means maximum Date that d_t exceeds 3.3%



3.2 Electromagnetic Immunity Report
-General Description

Product Standard	EN 55024:1998+A1:2001+A2:2003	
	Test Type	Minimum Requirement
Basic Standard	EN 61000-4-2	Electrostatic Discharge (ESD) 8kV for Air, 4kV for Contact Performance Criteria B
	EN 61000-4-3	Radio-frequency Electromagnetic field susceptibility (RS) 3V/m, 80%AM (1kHz), 80MHz-1000MHz, Performance Criteria A
	EN 61000-4-4	Electrical Fast transient/ Burst (EFT) Power Line:1kV, Signal:0.5kV Performance Criteria B
	EN 61000-4-5	Surge test 1.2/50us (open circuit voltage) 8/20us (short circuit current) AC Power port (Line->ground 2kV, line->line 1kV) Communication Port (1.2/50us, 1kV) Performance Criteria B
	EN 61000-4-6	Conducted radio frequency disturbance test (CS) 150kHz-80MHz, 3Vrms, 80%AM (1kHz) Performance Criteria A
	EN 61000-4-8	Power Frequency Magnetic Field(PFMF) 50Hz ,1A/m Performance Criteria A
	EN 61000-4-11	Voltage Dips: 1) >95% reduction for 0.5 periods. Performance Criteria B 2) 30% reduction for 25 periods. Performance Criteria C Voltage interrupt: >95% reduction for 0.5 periods. Performance Criteria C



-General performance criteria description

Criteria A	The apparatus shell continues to operate as intended without operator intervention. No degradation of performance or loss of function is allowed below a performance level specified by the manufacturer, when the apparatus is used as intended. The performance level may be replaced by a permissible loss of performance. If the manufacturer does not specify the minimum performance level or the permissible performance loss, then either of these may be derived from the product description and documentation, and by what the user may reasonably expect from the equipment if used as intended.
Criteria B	After test, the apparatus shell continues to operate as intended without operator intervention. No degradation of performance or loss of function is allowed, after the application of the phenomenon below a performance level specified by the manufacturer, when the apparatus is used as intended. The performance level may be replaced by a permissible loss of performance. During the test, degradation of performance is however allowed. However, no change of operating state if stored data is allowed to persist after the test. If the manufacturer does not specify the minimum performance level or the permissible performance loss, then either of these may be derived from the product description and documentation, and by what the user may reasonably expect from the equipment if used as intended.
Criteria C	Temporary loss of function is allowed, provided the functions is self-recoverable or can be restored by the operation of controls by the user in accordance with the manufacturer instructions. Functions, and/or information stored in non-volatile memory, or protected by a battery backup, shall not be lost.



3.2.1 Electrostatic Discharge (ESD) Immunity Measurement

The product was tested and met the requirements specified in EN 61000-4-2

- Measurement Procedures Utilized for ESD

The discharges shall be applied in two ways:

a) Contact discharges to the conductive surfaces and coupling planes:

The EUT shall be exposed to at least 200 discharges, 100 each at negative and positive polarity, at a minimum of four test points. One of the test points shall be subjected to at least 50 indirect discharges to the center of the front edge of the Horizontal Coupling Plane (HCP). The remaining three test points shall each receive at least 50 direct contact discharges. If no direct contact test points, then at least 200 indirect discharges shall be applied in the indirect mode. Test shall be performed at a maximum repetition rate of one discharge per second.

b) Air discharges at slots and apertures and insulating surfaces:

On those parts of the EUT where it is not possible to perform contact discharge testing, the equipment should be investigated to identify user accessible points where breakdown may occur. Such points are tested using the air discharge method. This investigation should be restricted to those area normally handled by the user. A minimum of 10 single air discharges shall be applied to the selected test point for each such area.

The basic test procedure was in accordance with IEC 61000-4-2:

- a) The EUT was located 0.1 m minimum from all side of the HCP (dimensions 1.6m x 0.8m).
- b) The support units were located another table 30 cm away from the EUT, but direct support unit was/were located at same location as EUT on the HCP and keep at a distance of 10 cm with EUT.
- c) The time interval between two successive single discharges was at least 1 second.
- d) Contact discharges were applied to the non-insulating coating, with the pointed tip of the generator penetrating the coating and contacting the conducting substrate.
- e) Air discharges were applied with the round discharge tip of the discharge electrode approaching the EUT as fast as possible (without causing mechanical damage) to touch the EUT. After each discharge, the ESD generator was removed from the EUT and re-triggered for a new single discharge. The test was repeated until all discharges were complete.
- f) At least ten single discharges (in the most sensitive polarity) were applied at the front edge of each HCP opposite the center point of each unit of the EUT and 0.1 meters from the front of the EUT. The long axis of the discharge electrode was in the plane of the HCP and perpendicular to its front edge during the discharge.



g) At least ten single discharges (in the most sensitive polarity) were applied to the center of one vertical edge of the Vertical Coupling Plane (VCP) in sufficiently different positions that the four faces of the EUT were completely illuminated. The VCP (dimensions 0.5m x 0.5m) was placed vertically to and 0.1 meters from the EUT.

- Test Setup

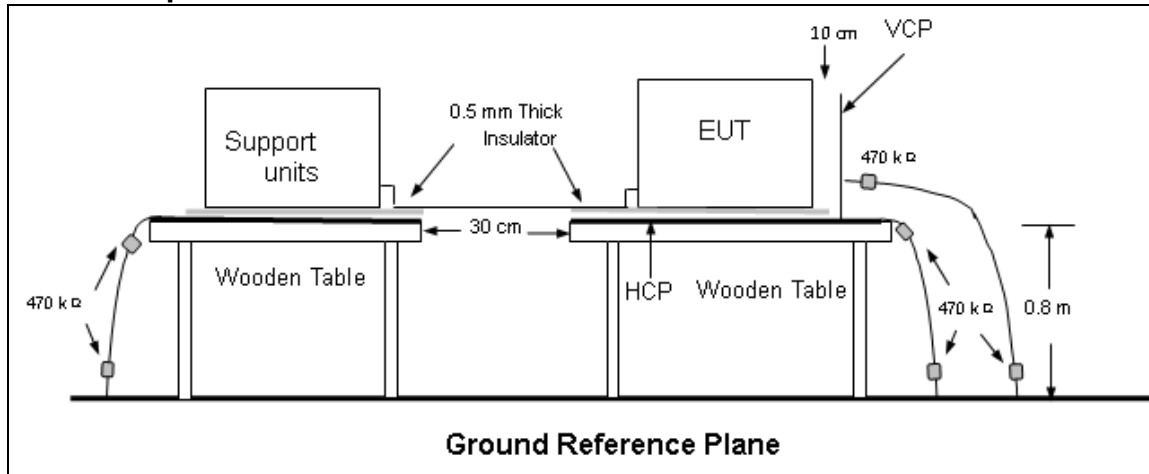

For the actual test configuration, please refer to the related item – Photographs of the Test Configuration.

-Test Condition

Equipment Tested	Laptop Computer
Test Software	H pattern
Test Standard	EN 61000-4-2
Test Operator	Andy Zhang
Date of Test	11/18/2011
Relative Humidity	48%
Temperature	31°C
Atmospheric Pressure	101kPa

**-Test Results**

Amount of Discharge	Voltage	Coupling	Performance Criteria	Result (Pass/ Fail)
10 /Point	± 2 kV	Air Discharge	B	Pass
10 /Point	± 4 kV	Air Discharge	B	Pass
10 /Point	± 8 kV	Air Discharge	B	Pass
25 /Point	± 2 kV	Contact Discharge	B	Pass
25 /Point	± 4 kV	Contact Discharge	B	Pass
25 /Point	± 2 kV	Indirect Discharge HCP	B	Pass
25 /Point	± 4 kV	Indirect Discharge HCP	B	Pass
25 /Point	± 2kV	Indirect Discharge VCP (Right)	B	Pass
25 /Point	± 4 kV	Indirect Discharge VCP (Right)	B	Pass
25 /Point	± 2 kV	Indirect Discharge VCP (Left)	B	Pass
25 /Point	± 4 kV	Indirect Discharge VCP (Left)	B	Pass



3.2.2 Radiated Electromagnetic Field Immunity Test

The product was tested and met the requirements specified in EN 61000-4-3

- Measurement Procedures Utilized for RS

- 1) The testing was performed in a fully anechoic chamber. The transmit antenna was located at a distance of 3 meters from the EUT.
- 2) The frequency range is swept from 80 MHz to 1000 MHz, with the signal 80% amplitude modulated with a 1 KHz sine-wave. The rate of sweep did not exceed 1.5×10^{-3} decade/s, where the frequency range is swept incrementally; the step size was 1% of preceding frequency value.
- 3) The dwell time at each frequency shall be not less than the time necessary for the EUT to be able to respond.
- 4) The test was performed with the EUT exposed to both vertically and horizontally polarized fields on each of the four sides.

- Test Setup

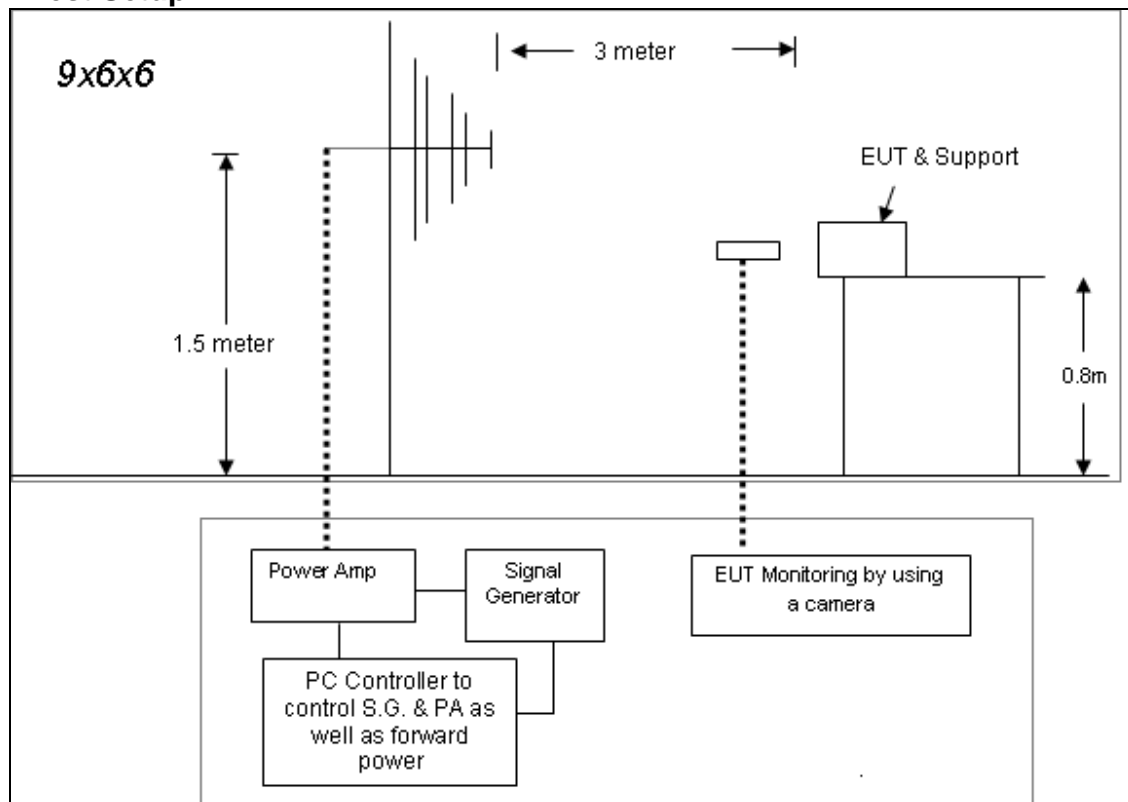

For the actual test configuration, please refer to the related item - Photographs of the Test Configuration.



-Test Condition

Equipment Tested	Laptop Computer
Test Software	H pattern
Test Standard	EN 61000-4-3
Test Operator	Andy Zhang
Date of Test	11/17/2011
Relative Humidity	58%
Temperature	24°C
Atmospheric Pressure	100.5kPa

-Test Results

Test level: 3V/m

Steps: 1 % of fundamental

Dwell Time: 3 sec

Range (MHz)	Modulation	Polarity	Position	Performance Criteria	Result (Pass/Fail)
80-1000	Yes	H	B/F/L/R	A	Pass
80-1000	Yes	V	B/F/L/R	A	Pass



3.2.3 Fast Transient/Burst Immunity Test

The product was tested and met the requirements specified in EN 61000-4-4

- Measurement Procedures Utilized for EFT

- 1) Both positive and negative polarity discharges were applied.
- 2) The length of the “hot wire” from the coaxial output of the EFT generator to the terminals on the EUT should not exceed 1 meter.
- 3) The duration time of each test sequential was 1 minute.
- 4) The transient/burst waveform was in accordance with EN 61000-4-4, 5/50ns.
- 5) AC Power Cord uses 0.5m+/-0.05m long cable otherwise AC power cord is in accordance with manufacture.

- Test Setup

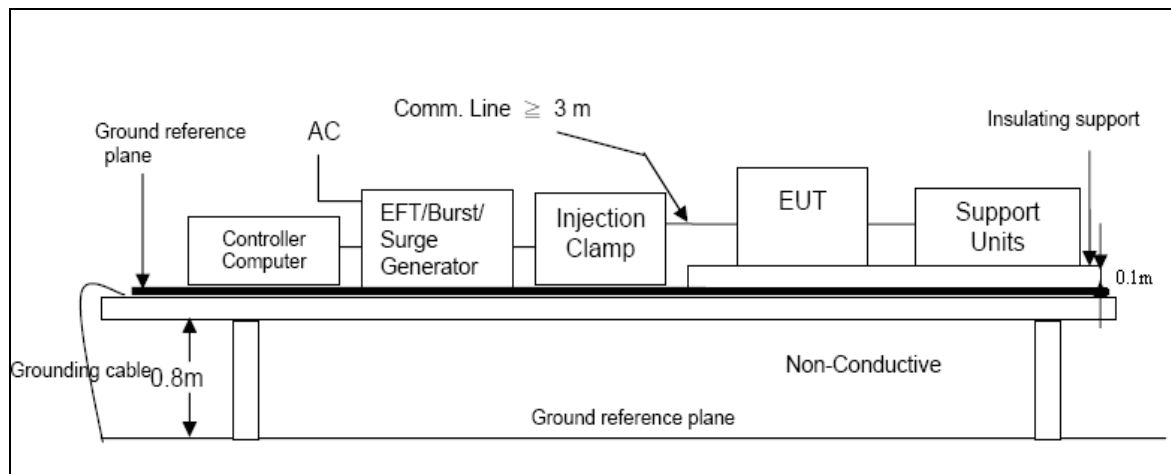
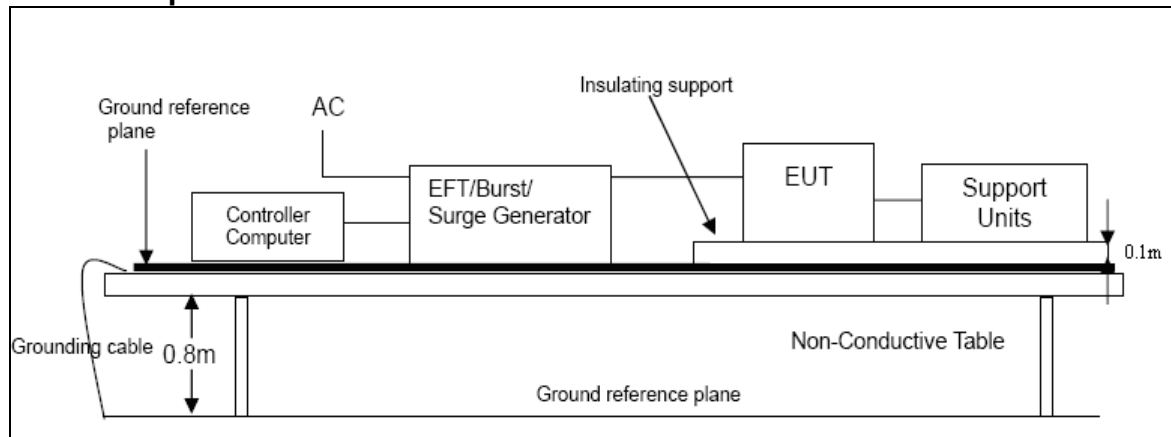

For the actual test configuration, please refer to the related item – Photographs of the Test Configuration



-Test Condition

Equipment Tested	Laptop Computer
Test Software	H pattern
Test Standard	EN 61000-4-4
Test Operator	Andy Zhang
Date of Test	11/18/2011
Relative Humidity	59%
Temperature	22°C
Atmospheric Pressure	101kPa

-Test Results

Inject Line	Voltage	Inject Method	Performance Criteria	Result (Pass/ Fail)
L	± 1 KV	Direct	B	Pass
N	± 1 KV	Direct	B	Pass
L + N	± 1 KV	Direct	B	Pass



3.2.4 Surge Immunity Test

The product was tested and met the requirements specified in EN 61000-4-5

- Measurement Procedures Utilized for Surge

1) For EUT power supply:

The surge is applied to the EUT power supply terminals via the capacitive coupling network. Decoupling networks are required in order to avoid possible adverse effects on equipment not under test that may be powered by the same lines, and to provide sufficient decoupling impedance to the surge wave. The power cord between the EUT and the coupling/decoupling networks was shorter than 2 meters in length.

2) For test applied to unshielded un-symmetrically operated interconnection lines of EUT:

The surge was applied to the lines via the capacitive coupling. The coupling / decoupling networks didn't influence the specified functional conditions of the EUT. The interconnection line between the EUT and the coupling/decoupling networks was shorter than 2 meters in length.

3) For test applied to unshielded symmetrically operated interconnection / telecommunication lines of EUT:

The surge was applied to the lines via gas arrestors coupling. Test levels below the ignition point of the coupling arrestor were not specified. The interconnection line between the EUT and the coupling/decoupling networks was shorter than 2 meters in length.

- Test Setup

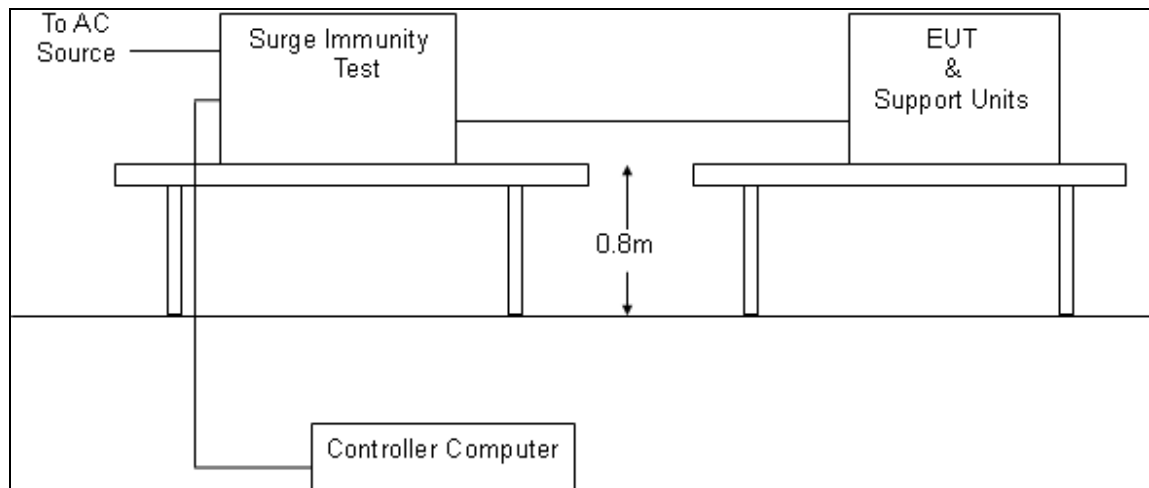

For the actual test configuration, please refer to the related item - Photographs of the Test Configuration.



-Test Condition

Equipment Tested	Laptop Computer
Test Software	H pattern
Test Standard	EN 61000-4-5
Test Operator	Andy Zhang
Date of Test	11/19/2011
Relative Humidity	59%
Temperature	22°C
Atmospheric Pressure	101kPa

-Test Results

Coupling Line	Voltage	Polarity	Coupling Method	Performance Criteria	Result (Pass/Fail)
L1-L2	1 KV	Positive	Capacitive	B	Pass
L1-L2	1 KV	Negative	Capacitive	B	Pass



3.2.5 Conducted Disturbance, Induced Radio-Frequency Field

The product was tested and met the requirements specified in EN 61000-4-6

- Measurement Procedures Utilized for CS

The EUT shall be tested within its intended operating and climatic conditions.

The test shall be performed with the test generator connected to each of the coupling and decoupling devices in turn, while the other non-excited RF input ports of the coupling devices are terminated by a 50-ohm load resistor.

The frequency range was swept from 150 kHz to 80MHz, using the signal level established during the setting process and with a disturbance signal of 80 % amplitude. The signal was modulated with a 1 kHz sine wave, pausing to adjust the RF signal level or the switch coupling devices as necessary. The sweep rate was 1.5×10^{-3} decades/s. Where the frequency range is swept incrementally, the step size was 1 % of preceding frequency value from 150 kHz to 80 MHz.

The dwell time at each frequency was less than the time necessary for the EUT to be exercised, and able to respond. Sensitive frequencies such as clock frequency (ies) and harmonics or frequencies of dominant interest, was analyzed separately.

Attempts were made to fully exercise the EUT during testing, and to fully interrogate all exercise modes selected for susceptibility.

- Test Setup

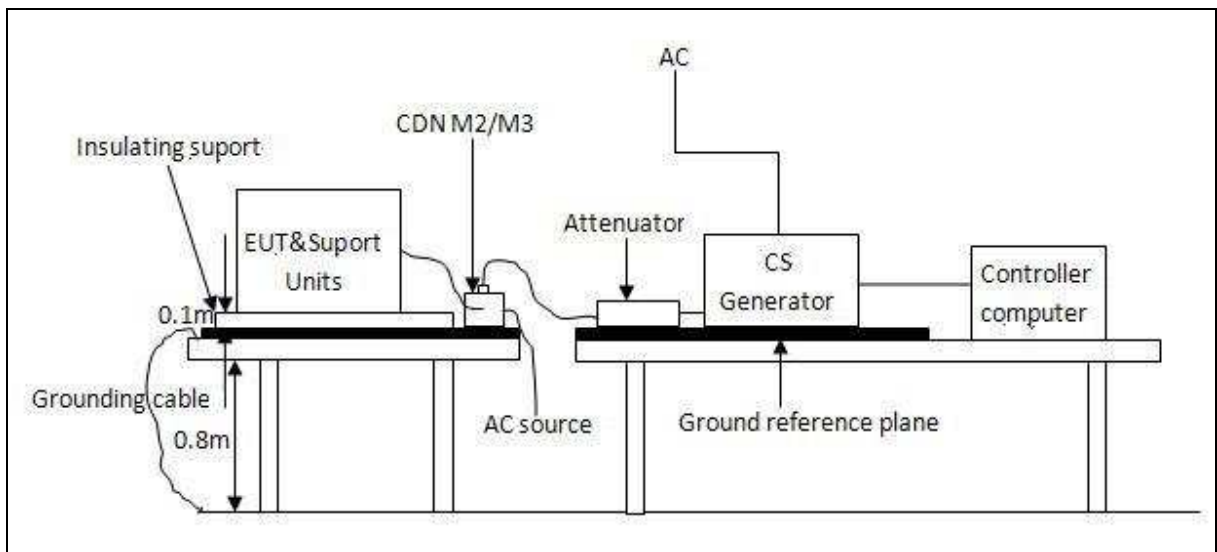

- Note:** 1). The EUT is setup 0.1m above Ground Reference Plane
2). The CDNs and / or EM clamp used for real test depends on ports and cables configuration of EUT.
For the actual test configuration, please refer to the related item –
Photographs of the Test Configuration



-Test Condition

Equipment Tested	Laptop Computer
Test Software	H pattern
Test Standard	EN 61000-4-6
Test Operator	Andy Zhang
Date of Test	11/19/2011
Relative Humidity	58%
Temperature	22°C
Atmospheric Pressure	101kPa

-Test Results

Frequency Step: 1% of fundamental

Dwell Time: 3 sec

Test Ports: mains

Range (MHz)	Field	Modulation	Performance Criteria	Result (Pass/ Fail)
0.15-80	3V	Yes	A	Pass

3.2.6 Power Frequency Magnetic Field Immunity Test

The product was tested and met the requirements specified in EN 61000-4-8

- Measurement Procedures Utilized for PFMF

- 1) The equipment is configured and connected to satisfy its functional requirements. It shall be placed on the GRP with the interposition of a 0.1m-thick insulating support.
- 2) The equipment cabinets shall be connected to the safety earth directly on the GRP via the earth terminal of the EUT.
- 3) The power supply, input and output circuits shall be connected to the sources of power supply, control and signal.
- 4) The cables supplied or recommended by the equipment manufacturer shall be used. 1 meter of all cables used shall be exposed to the magnetic field.

- Test Setup

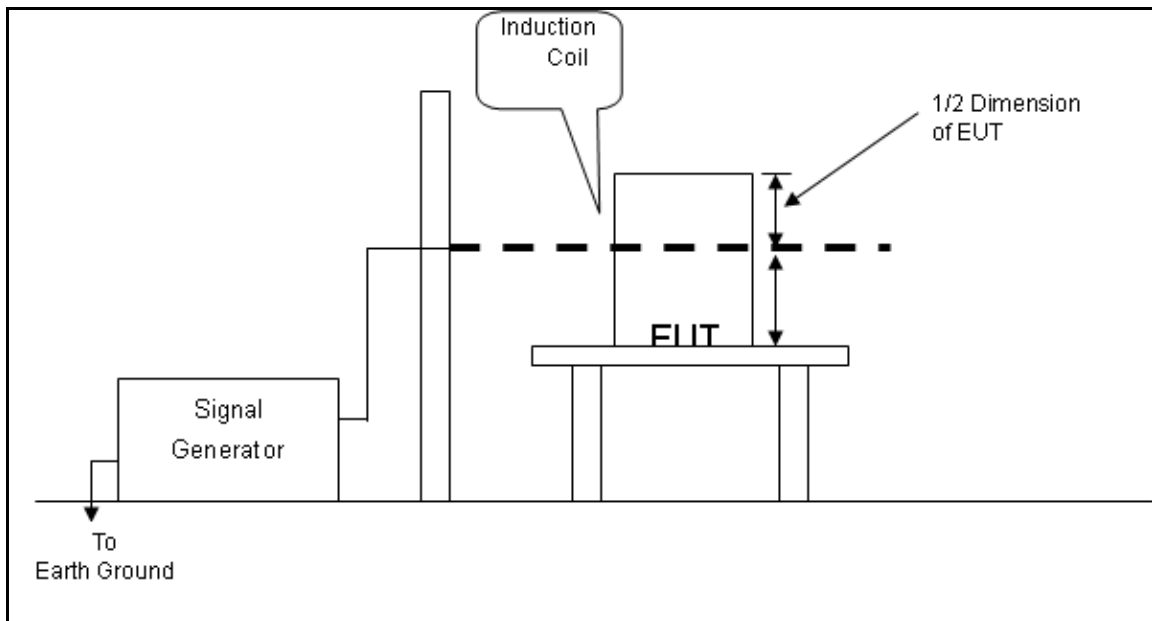

For the actual test configuration, please refer to the related item – Photographs of the Test Configuration.



-Test Condition

Equipment Tested	Laptop Computer
Test Software	H pattern
Test Standard	EN 61000-4-8
Test Operator	Andy Zhang
Date of Test	11/19/2011
Relative Humidity	58%
Temperature	22°C
Atmospheric Pressure	101kPa

-Test Results

Power Freq.: 50Hz

Orientation	Field	Performance Criteria	Result (Pass/Fail)
X	1A/m	A	Pass
Y	1A/m	A	Pass
Z	1A/m	A	Pass



3.2.7 Voltage Dips / Short Interruptions and Interruptions Test

The product was tested and met the requirements specified in EN 61000-4-11

- Measurement Procedures Utilized for Dips

- 1) The EUT and support units were located on a wooden table, 0.8 m away from ground floor.
- 2) Setting the parameter of tests and then perform the test software of test simulator.
- 3) Conditions changes to occur at 0 degree crossover point of the voltage waveform.
- 4) Recording the test result in test record form.

- Test Setup

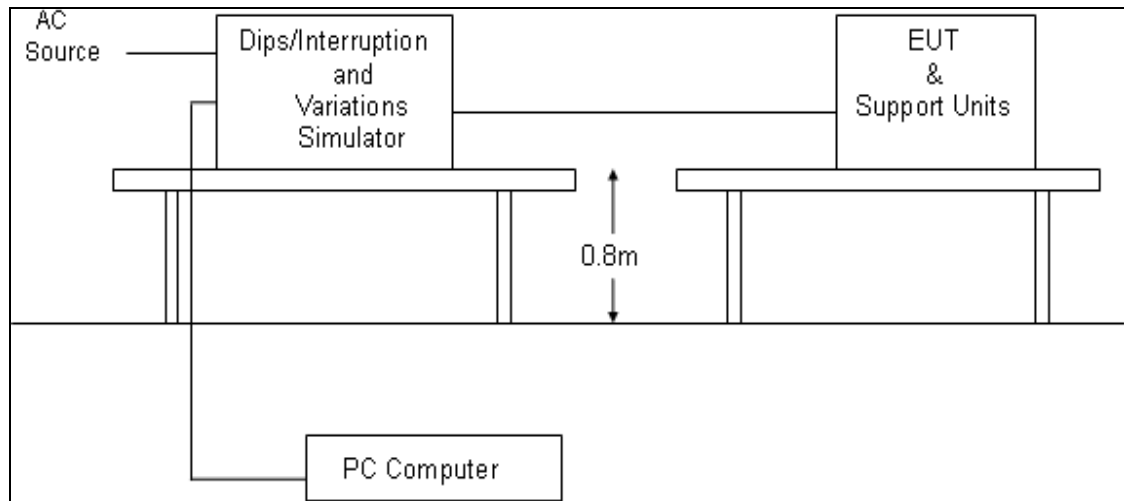

For the actual test configuration, please refer to the related item – Photographs of the Test Configuration.



-Test Condition

Equipment Tested	Laptop Computer
Test Software	H pattern
Test Standard	EN 61000-4-11
Test Operator	Andy Zhang
Date of Test	11/19/2011
Relative Humidity	58%
Temperature	22°C
Atmospheric Pressure	101k Pa

-Test Results

The duration with a sequence of three dips/interruptions with interval of 10s minimum (Between each test event)

Voltage Dips:

Test Level % U _T	Reduction	Duration (periods)	Performance Criteria	Result (Pass/Fail)
0	> 95%	0.5	B	Pass
70	30%	25	C	Pass

Voltage Interruptions:

Test Level % U _T	Reduction	Duration (periods)	Performance Criteria	Result (Pass/Fail)
0	> 95%	250	C	Pass



SECTION 4: Test Arrangement Photos

4.1 Conducted Emissions (AC Power)





4.2 Radiated Emissions

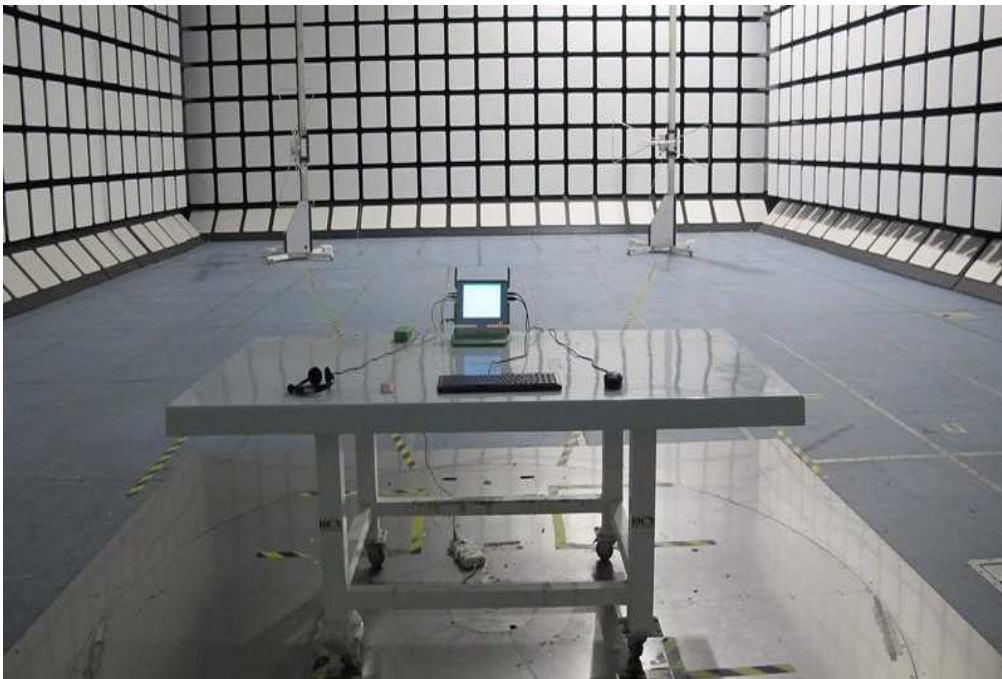

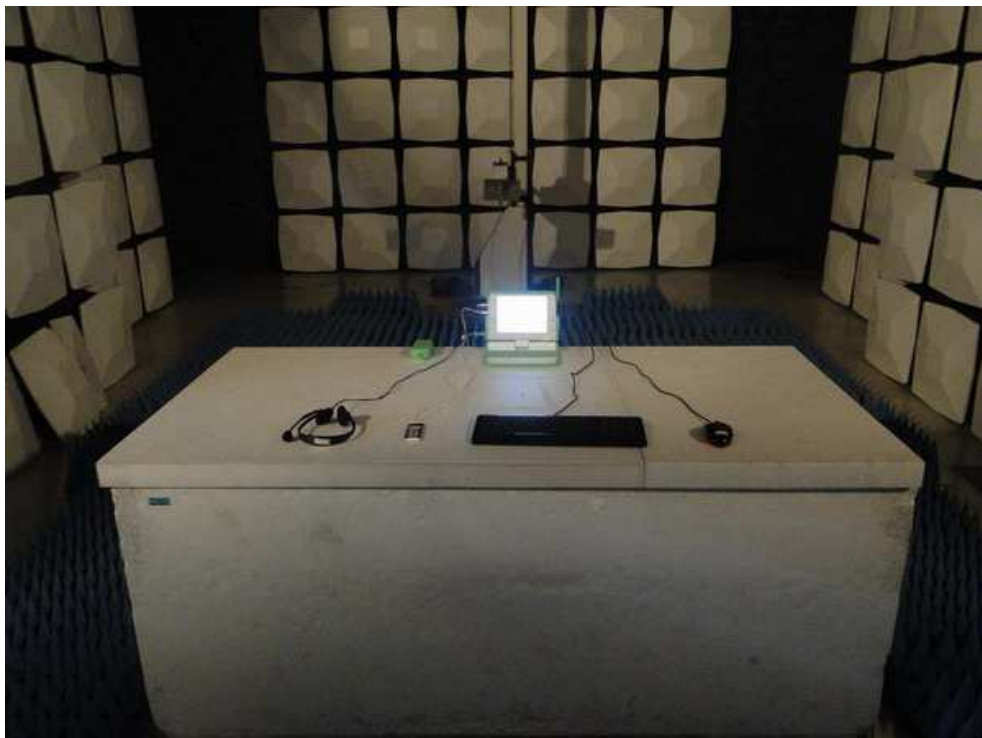
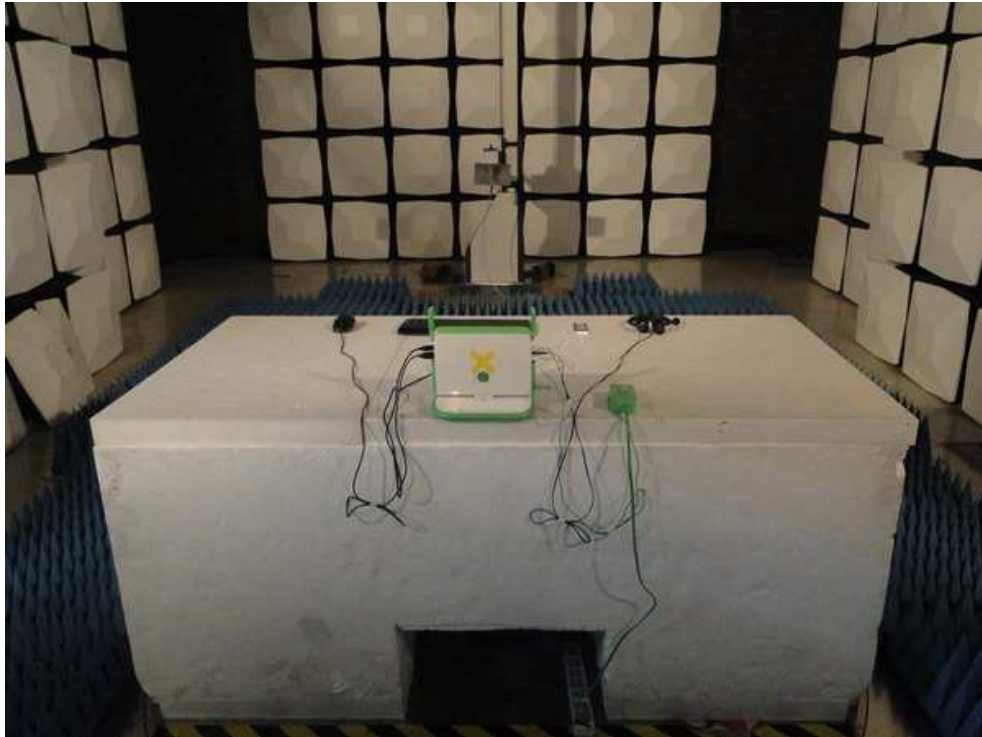



4.3 Power Harmonics and Flick Measurement





4.4 Electrostatic Discharge (ESD)

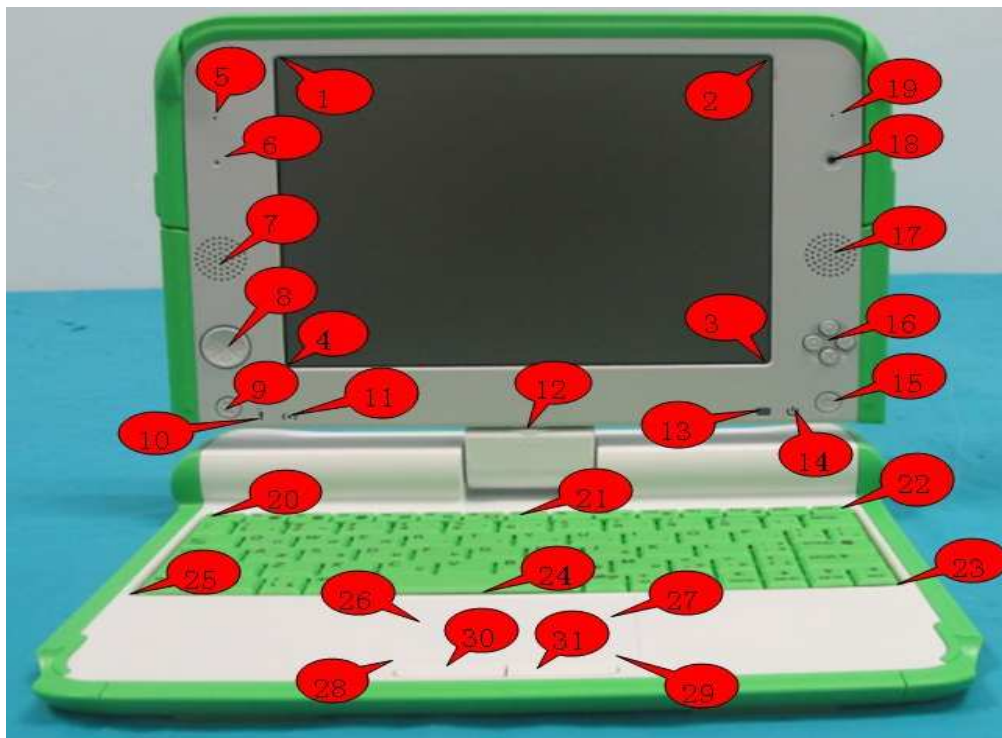
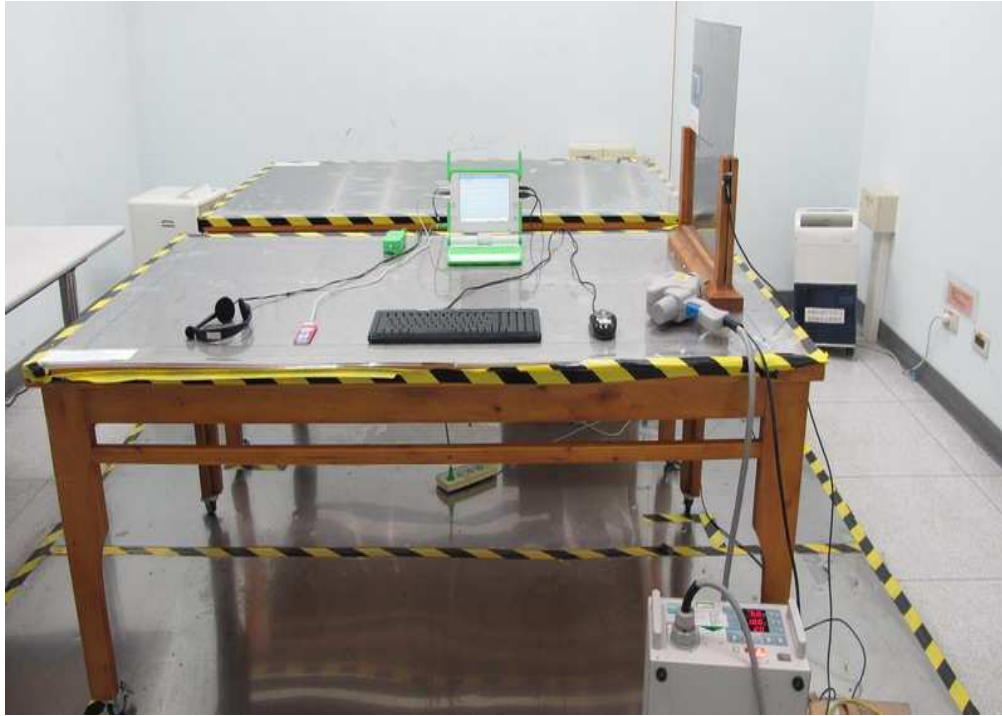

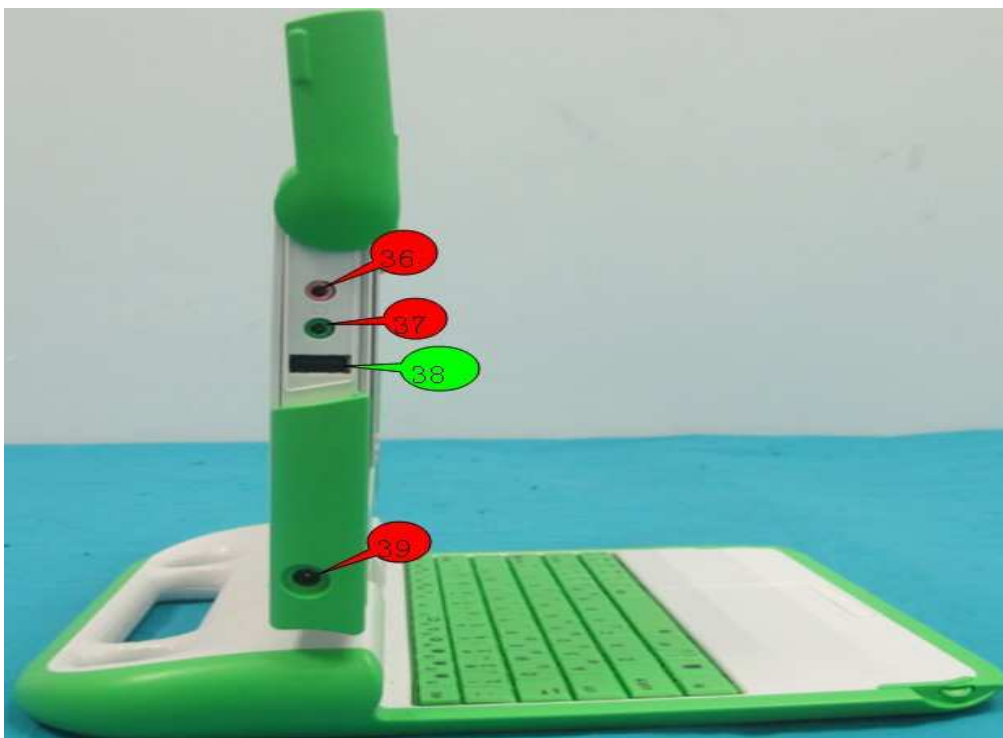

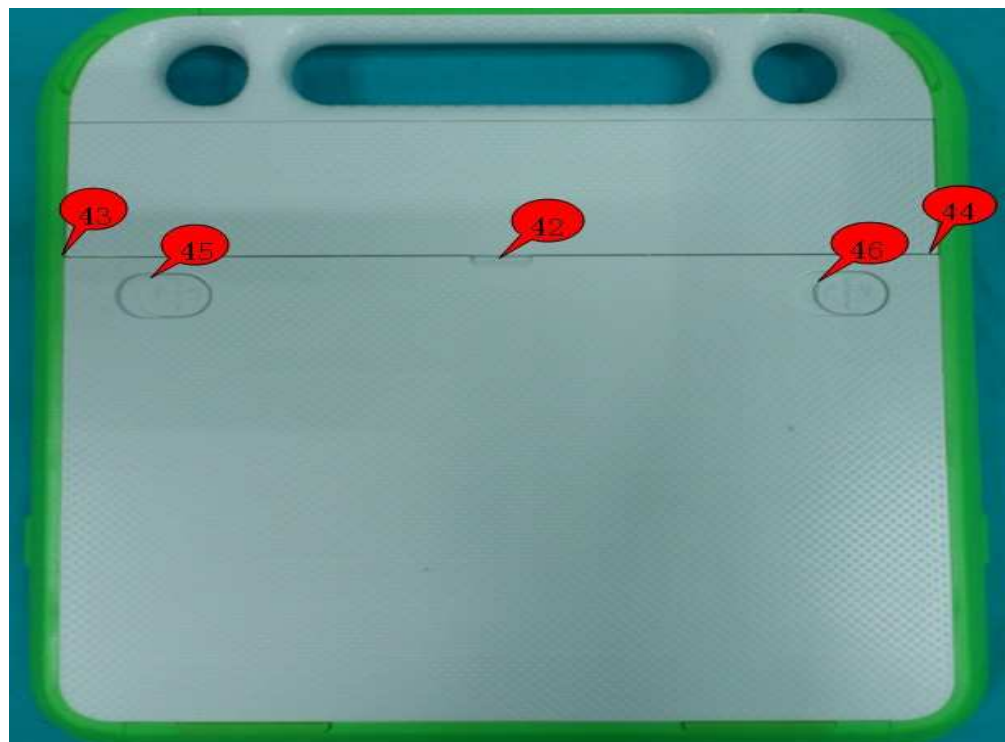
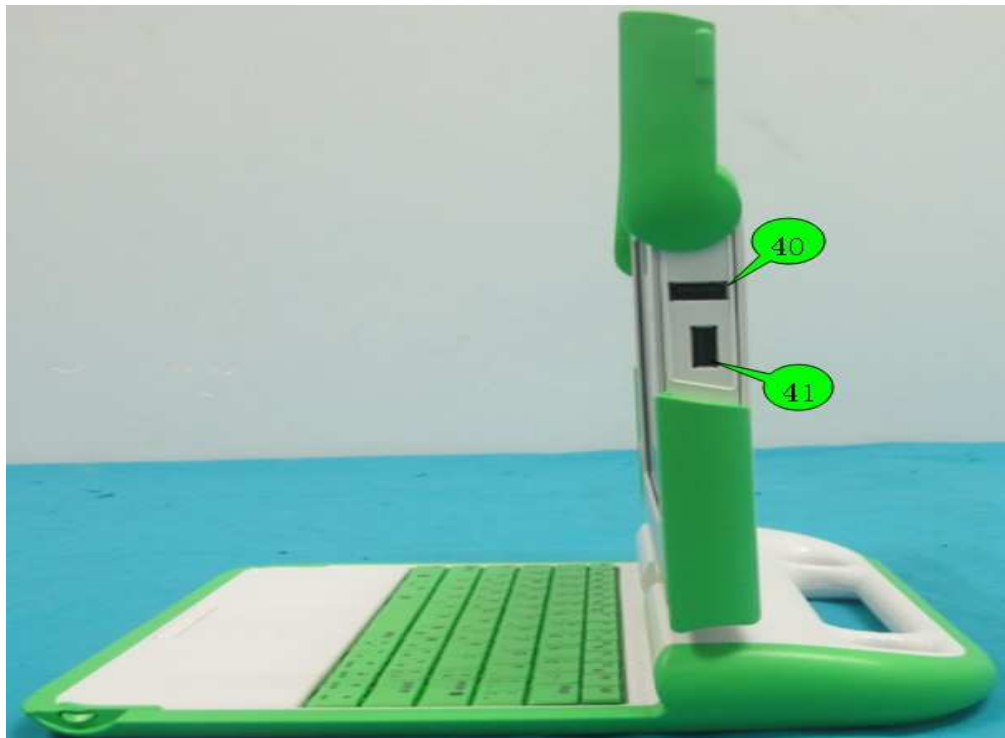



4.5 Radiated Electromagnetic Field Immunity Test



4.6 Fast Transient / Burst Immunity Test





4.7 Surge Immunity Test



4.8 Conducted Disturbance, Induced Radio-Frequency Field Immunity Test





4.9 Power Frequency Magnetic Field Immunity Test



4.10 Voltage Dips / Short Interruptions and Interruptions Test

